

INTRODUCTION.

Thank you for choosing the **SHOETRING** ARTF by SEAGULL MODELS COMPANY LTD. The **SHOETRING** was designed with the intermediate/advanced sport scale in mind. It is a semi scale airplane which is easy to fly and quick to assemble. The airframe is conventionally built using balsa, plywood to make it stronger than the average ARTF, yet the design allows the aeroplane to be kept light. You will find that most of the work has been done for you already. The motor mount has been fitted and the hinges are pre-installed. Flying the **SHOETRING** is simply a joy.

This instruction manual is designed to help you build a great flying aeroplane. Please read this manual thoroughly before starting assembly of your **SHOETRING**. Use the parts listing below to identify all parts.

WARNING.

Please be aware that this aeroplane is not a toy and if assembled or used incorrectly it is capable of causing injury to people or property. WHEN YOU FLY THIS AEROPLANE YOU ASSUME ALL RISK & RESPONSIBILITY.

If you are inexperienced with basic R/C flight we strongly recommend you contact your R/C supplier and join your local R/C Model Flying Club. R/C Model Flying Clubs offer a variety of training procedures designed to help the new pilot on his way to successful R/C flight. They will also be able to advise on any insurance and safety regulations that may apply.

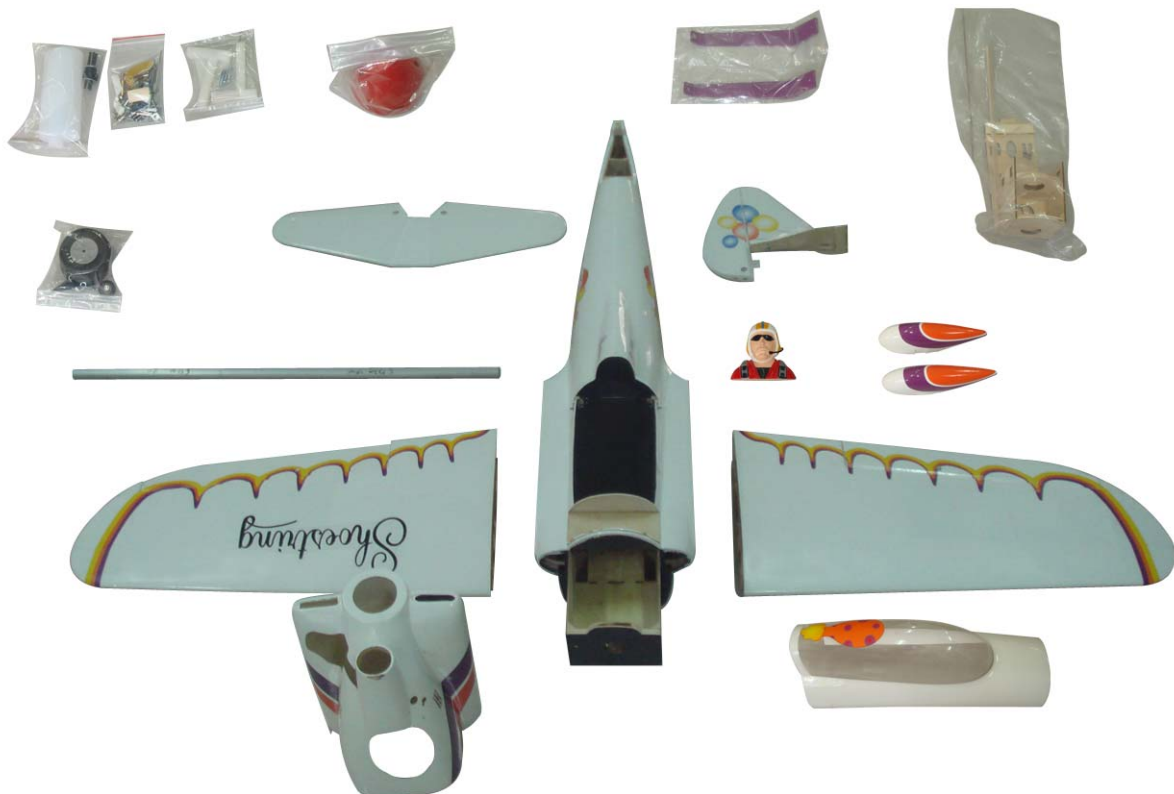
KIT CONTENTS

KIT CONTENTS

SEA14301	Fuselage
SEA14302	Wing set
SEA14303	Tail set
SEA14304	Fiberglass cowl
SEA14305	Landing gear
SEA14306	Canopy
SEA14307	Pilot
SEA14308	Fiberglass whl pants
SEA14309	Wheel
SEA14310	Aluminum wing tube
SEA14311	Engine mount
SEA14312	Fuel tank
SEA14313	Spinner
SEA14314	EP conversion pack
SEA14315	Hardware bag

ADDITIONAL ITEMS REQUIRED.

- 0.61-0.75 cu.in 2-stroke
- 0.91-1.00 cu.in 4-stroke
- Radio System required 4 channels with 5 digital servos.
- Glow plug to suit engine
- Propeller to suit engine
- Protective foam rubber for radio system
- Silicone fuel line

TOOLS & SUPPLIES NEEDED.

- Thick cyanoacrylate glue
- 30 minute epoxy
- 5 minute epoxy
- Hand or electric drill
- Assorted drill bits
- Modelling knife
- Straight edge ruler
- 2mm ball driver
- Phillips head screwdriver
- 220 grit sandpaper
- 90° square or builder's triangle
- Wire cutters
- Masking tape & T-pins
- Thread-lock
- Paper towels

HINGING THE AILERONS.

Note: *The control surfaces, including the ailerons, elevators, and rudder, are prehinged with hinges installed, but the hinges are not glued in place. It is imperative that you properly adhere the hinges in place per the steps that follow using a high-quality thin C/A glue.*

- 1) Carefully remove the aileron from one of the wing panels. Note the position of the hinges.

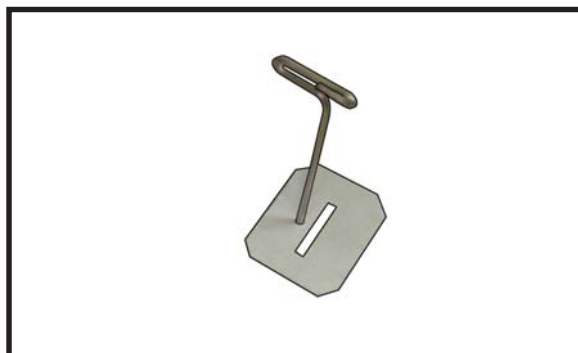

- 2) Remove each hinge from the wing panel and aileron and place a T-pin in the center of each hinge. Slide each hinge into the wing panel until the T-pin is snug against the wing panel. This will help ensure an equal amount of hinge is on either side of the hinge line when the aileron is mounted to the aileron.

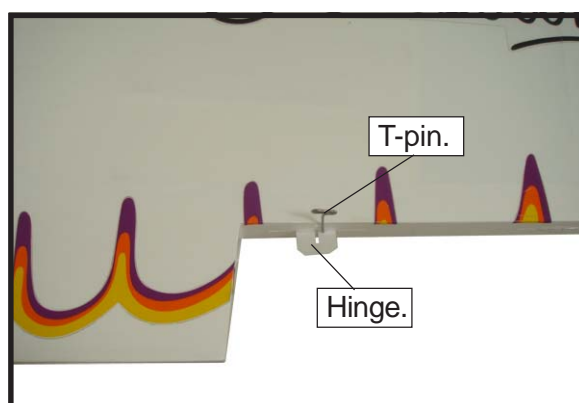

- 3) Slide the wing panel on the aileron until there is only a slight gap. The hinge is now centered on the wing panel and aileron. Remove the T-pins and snug the aileron against the wing panel. A gap of 1/64" or less should be maintained between the wing panel and aileron.

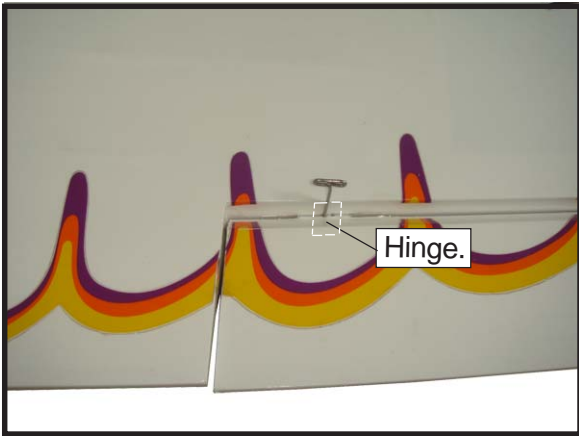

□ 4) Deflect the aileron and completely saturate each hinge with thin C/A glue. The aileron's front surface should lightly contact the wing during this procedure. Ideally, when the hinges are glued in place, a 1/64" gap or less will be maintained throughout the length of the aileron to the wing panel hinge line.

Note:

The hinge is constructed of a special material that allows the C/A to wick or penetrate and distribute throughout the hinge, securely bonding it to the wood structure of the wing panel and aileron.

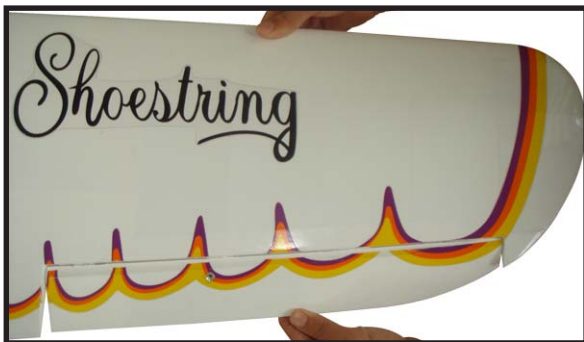
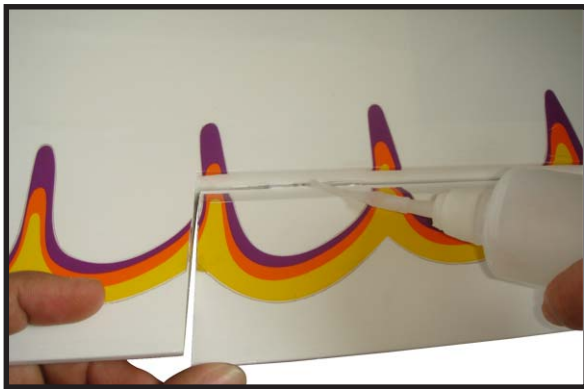

□ 5) Turn the wing panel over and deflect the aileron in the opposite direction from the opposite side. Apply thin C/A glue to each hinge, making sure that the C/A penetrates into both the aileron and wing panel.

□ 6) Using C/A remover/debonder and a paper towel, remove any excess C/A glue that may have accumulated on the wing or in the aileron hinge area.

□ 7) Repeat this process with the other wing panel, securely hinging the aileron in place.

□ 8) After both ailerons are securely hinged, firmly grasp the wing panel and aileron to make sure the hinges are securely glued and cannot be pulled out. Do this by carefully applying medium pressure, trying to separate the aileron from the wing panel. Use caution not to crush the wing structure.



Note: *Work the aileron up and down several times to "work in" the hinges and check for proper movement.*

HINGING THE ELEVATOR.

Glue the elevator hinges in place using the same techniques used to hinge the ailerons.

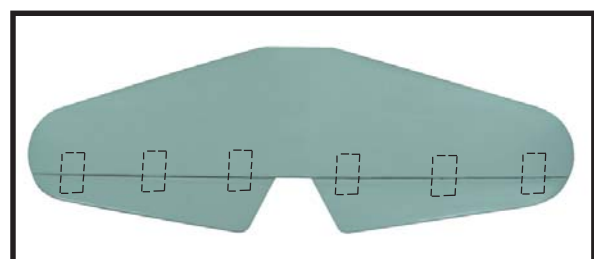

HINGING THE RUDDER.

Glue the rudder hinges in place using the same techniques used to hinge the ailerons.

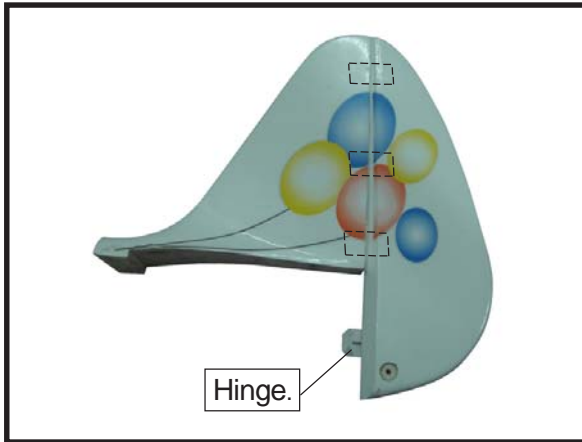

INSTALL ELEVATOR CONTROL HORN.

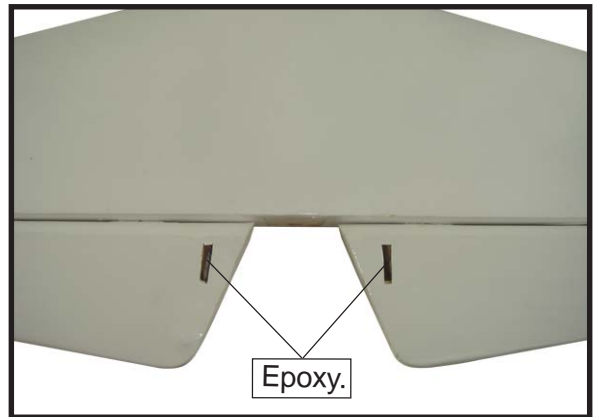
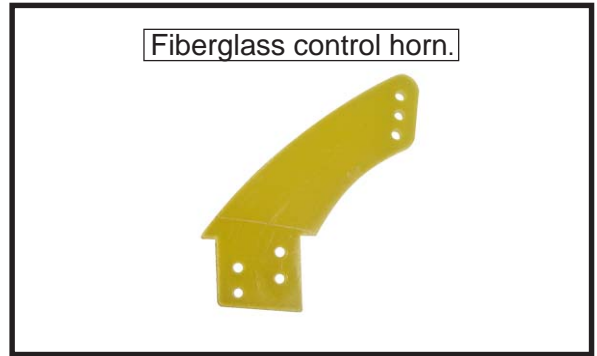

INSTALL AILERON CONTROL HORN.

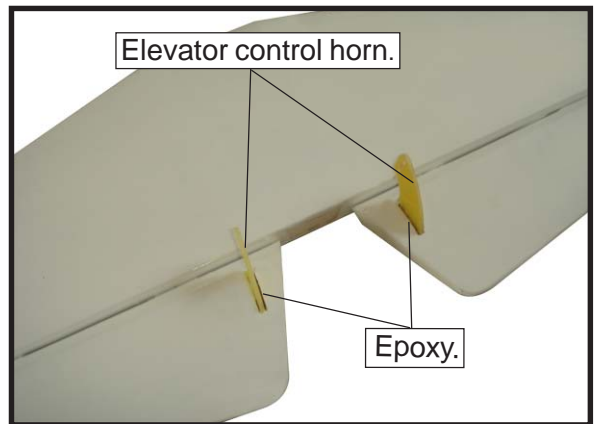
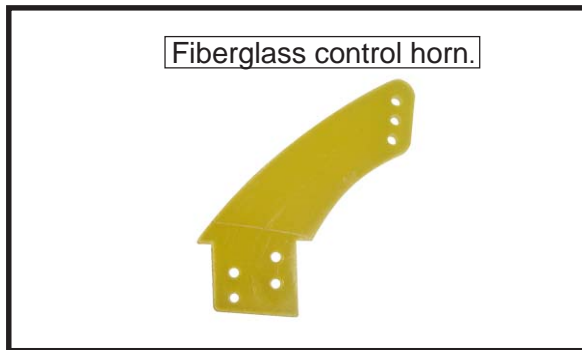

INSTALL RUDDER CONTROL HORN.

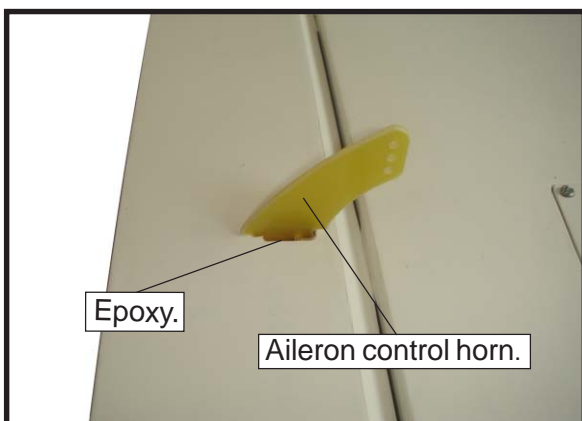
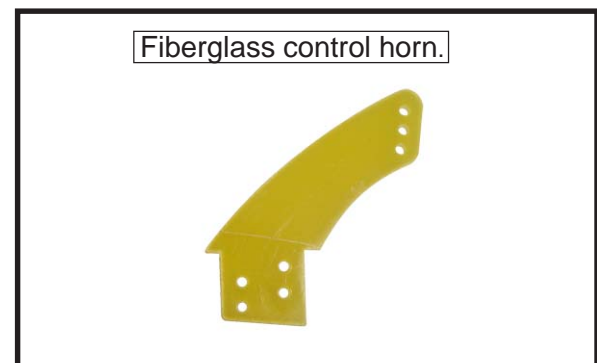

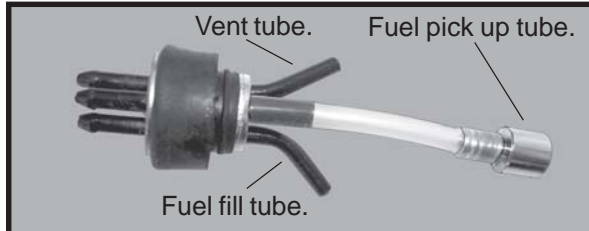

Carefully use a lighter or heat gun to permanently set the angle of the vent tube.

Important: *When the stopper assembly is installed in the tank, the top of the vent tube should rest just below the top surface of the tank. It should not touch the top of the tank.*

□ 4) Test fit the stopper assembly into the tank. It may be necessary to remove some of the flashing around the tank opening using a modeling knife. If flashing is present, make sure none falls into the tank.

□ 5) With the stopper assembly in place, the weighted pick-up should rest away from the rear of the tank and move freely inside the tank. The top of the vent tube should rest just below the top of the tank. It should not touch the top of the tank.

□ 6) When satisfied with the alignment of the stopper assembly tighten the 3 x 20mm machine screw until the rubber stopper expands and seals the tank opening. Do not overtighten the assembly as this could cause the tank to split.

FUEL TANK INSTALLATION.

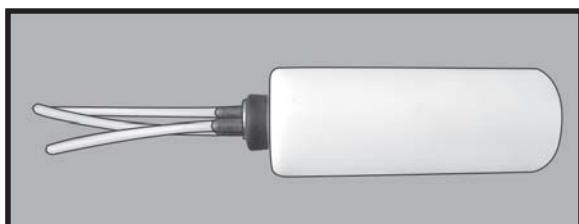

⚠ *You should mark which tube is the vent and which is the fuel pickup when you attach fuel tubing to the tubes in the stopper. Once the tank is installed inside the fuselage, it may be difficult to determine which is which.*

□ 7) Slide the fuel tank into the fuselage. Guide the lines from the tank through the hole in the firewall.

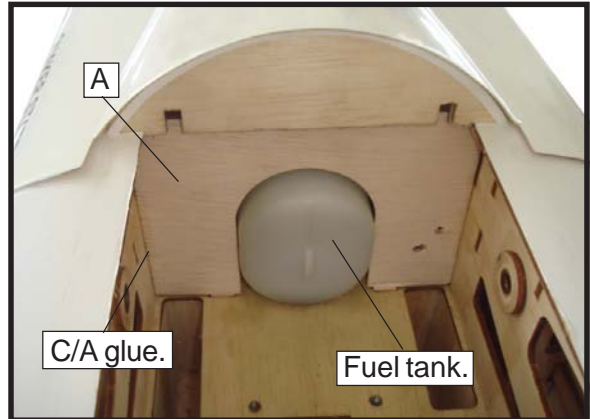

□ 8) Use balsa stick to help prevent moveable from transferring to the fuel tank.

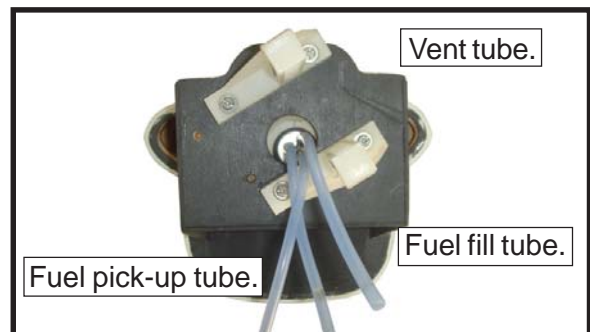
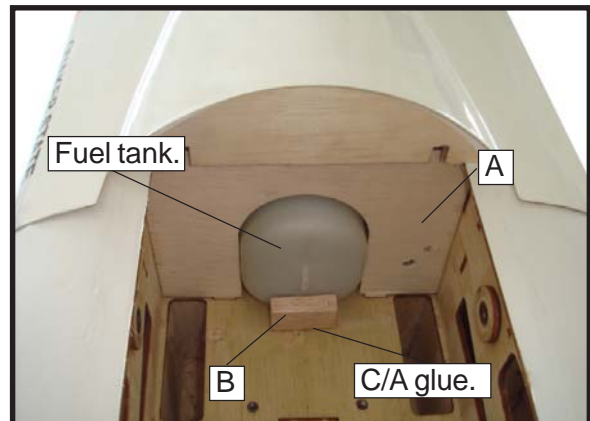

□ 9) Connect the lines from the tank to the engine and muffler. The vent line will connect to the muffler and the line from the clunk to the carburetor.

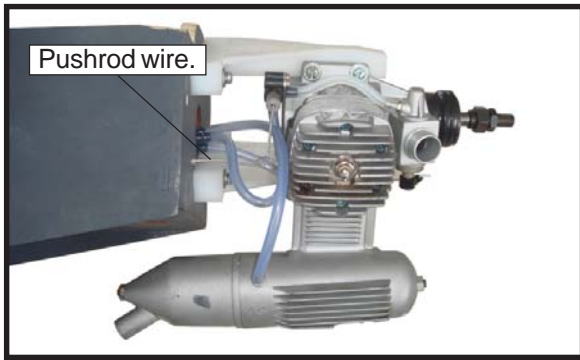

! *Blow through one of the lines to ensure the fuel lines have not become kinked inside the fuel tank compartment. Air should flow through easily.*

WHEEL AND WHEEL PANTS INSTALLATION.

□ 1) Locate the items necessary to install the wheel and wheel pants as shown.

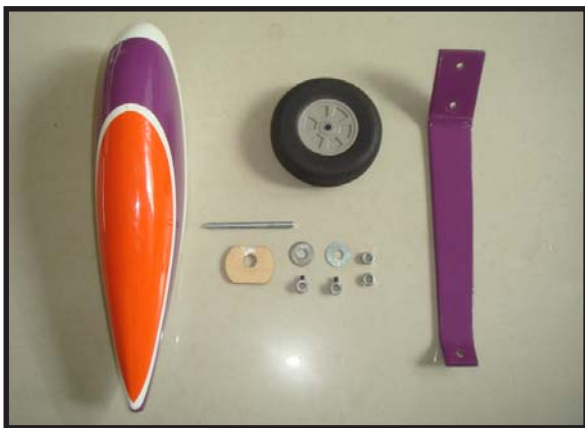

□ 2) Follow diagram below for wheel pant installation:

Use a drill and 4.2mm drill bit to drill a hole in the wheel pants.

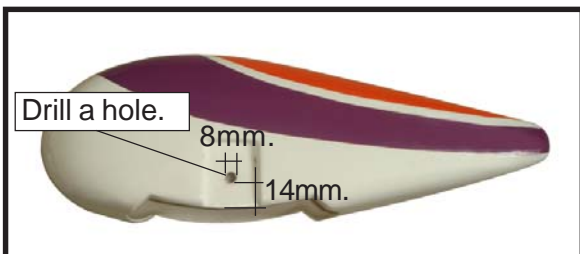

□ 3) You have to trim each axle using a tool cutting and cut-off wheel.

! *Caution when cutting the axles and wear protective goggles.*

□ 4) Slide the collar to the axle and setscrew the collars to secure the collar to the axle and then slide the wheel on the axle with a drop of oil on the axle so the wheel will spin freely when installed. Prepare a second collar and tighten the setscrew using hex wrench to secure the collar to the axle.

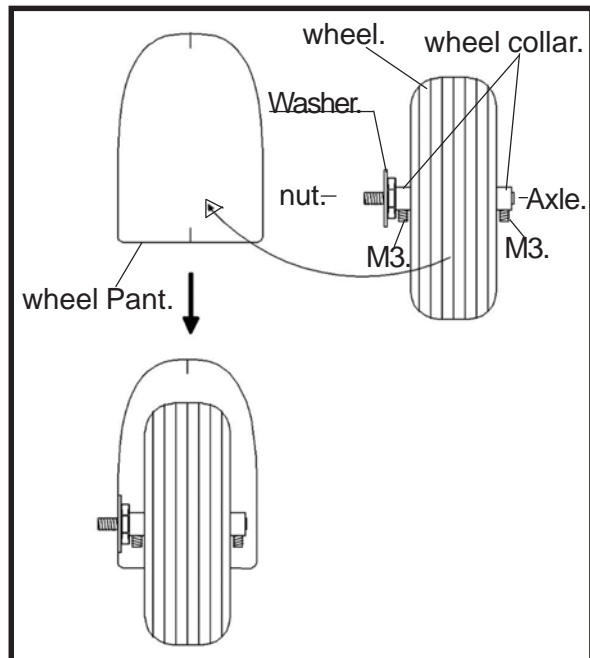
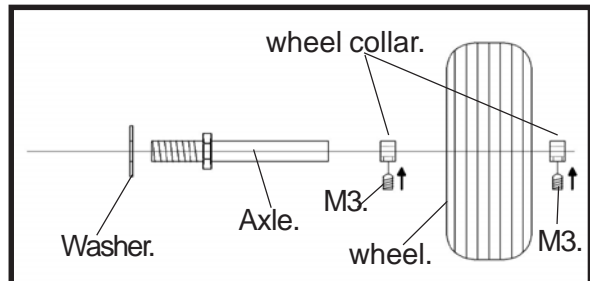

□ 5) Place the wheel assembly in the wheel pants. The threaded portion of the axle will fit the notch of the wheel pant as shown.

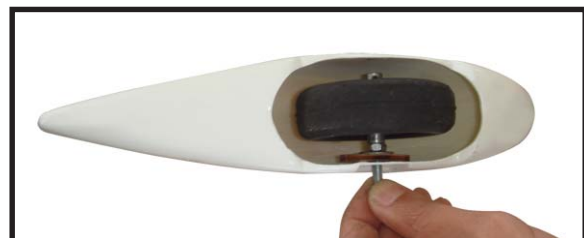

□ 6) Slide the threaded end of the axle through the hole in the bottom of the landing gear leg. Use a washer and locknut to tighten the axle to the landing gear. Make sure to use threadlock on the nut so it won't vibrate loose in flight as shown.

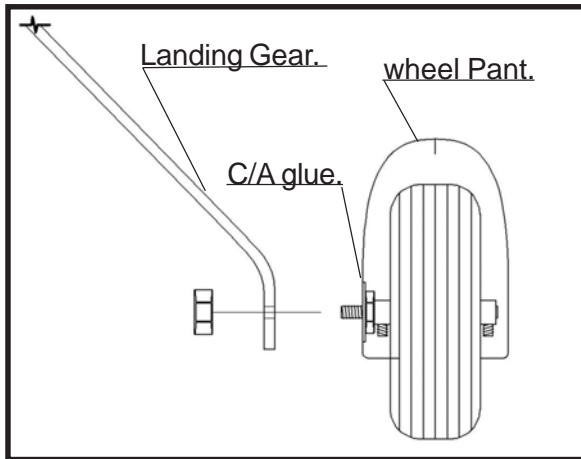

□ 7) Tighten the setcrews using a hex wrench to secure the collars on the axle over the flat spot to retain the wheel as shown.

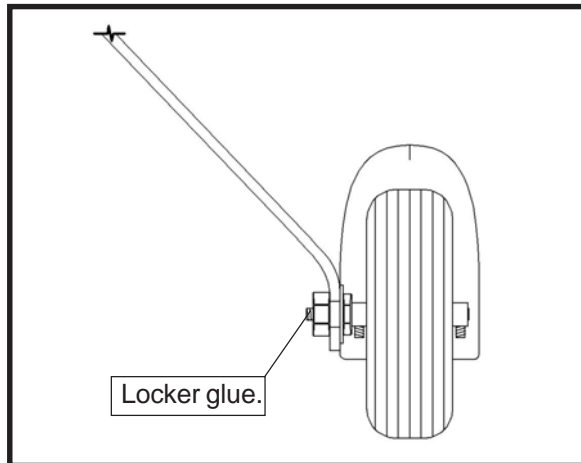

Repeat steps as above to attach remaining wheel pants to the landing gear.

INSTALLING THE MAIN LANDING GEAR TO FUSELAGE.

- 8) The blind nuts for securing the landing gear are already mounted inside the fuselage.
- 9) Using the hardware provided, mount the main landing gear to the fuselage.
- 10) Place the fuselage inverted on the workbench in a suitable stand. Set the landing gear in place and use a screwdriver to secure the landing gear to the fuselage using bolts M4x20mm and washers. Make sure to use the threadlock on the bolts so they don't vibrate loose.

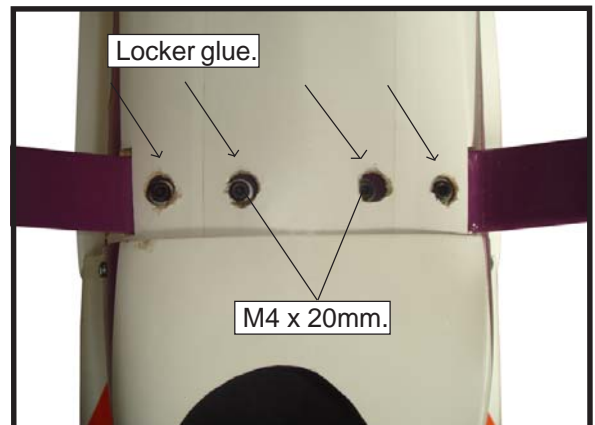

INSTALLING THE AILERON.

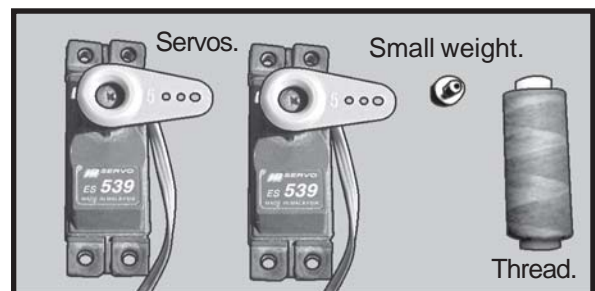

 *Because the size of servos differ, you may need to adjust the size of the precut opening in the mount. The notch in the sides of the mount allow the servo lead to pass through.*

1) Using a small weight (*Weighted fuel pick-up works well*) and string, feed the string through the wing as indicated.



2) Place the servo between the mounting blocks and space it from the hatch. Use a pencil to mark the mounting hole locations on the blocks.

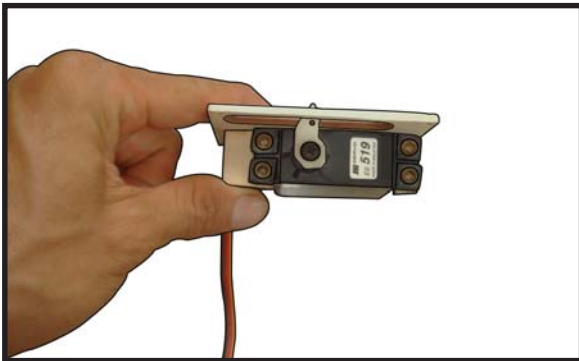

3) Use drill bit in a pin vise to drill the mounting holes in the blocks.

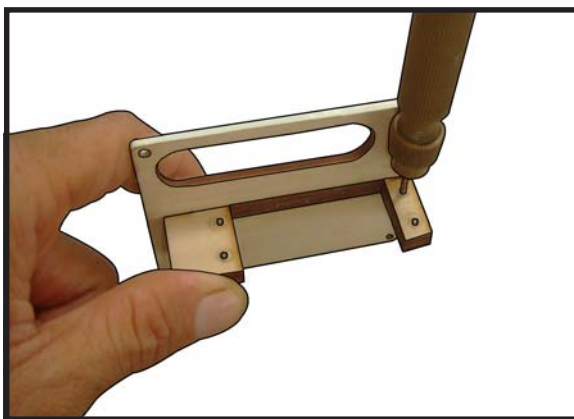

4) Apply 2-3 drops of thin C/A to each of the mounting holes. Allow the C/A to cure without using accelerator.

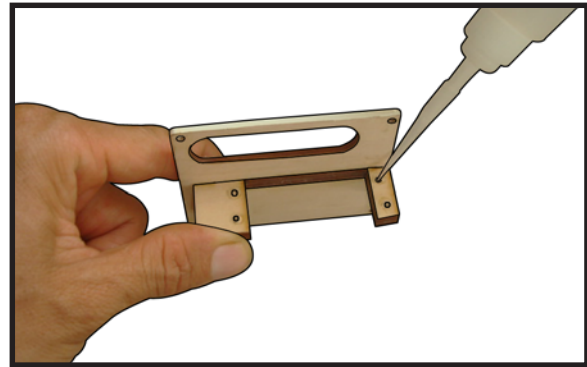

5) Use dental floss to secure the connection so they cannot become unplugged.

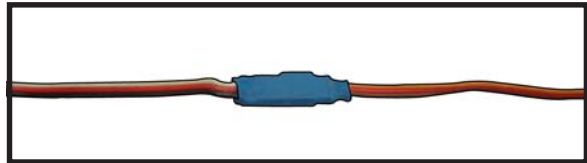

6) Secure the servo to the aileron hatch using Phillips screwdriver and the screws provided with the servo.

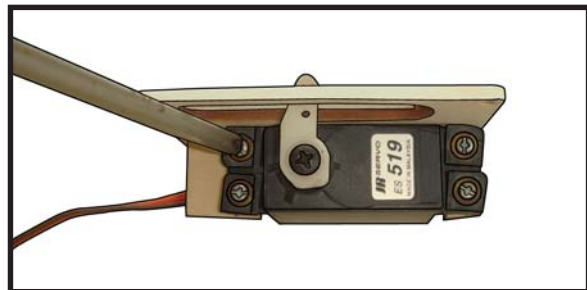

7) Apply 1-2 drops of thin C/A to each of the mounting tabs. Allow the C/A to cure without using accelerator.



8) A string has been provided in the wing to pull the aileron lead through to the wing root. Remove the string from the wing at the servo location and use the tape to attach it to the servo extension lead. Pull the lead through the wing and remove the string.

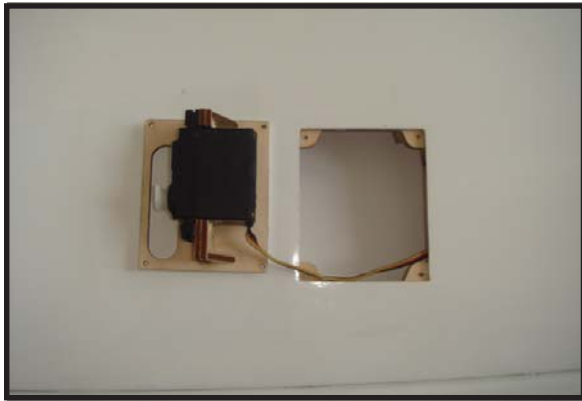
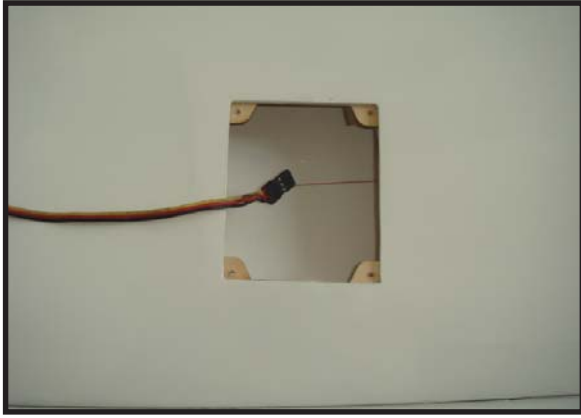

9) Set the aileron hatch in place and use a Phillips screw driver to install it with four wood screws.



INSTALLING THE FUSELAGE SERVO.

 *Because the size of servos differ, you may need to adjust the size of the precut opening in the mount. The notch in the sides of the mount allow the servo lead to pass through.*

- 1) Install the rubber grommets and brass collets onto the throttle servo. Test fit the servo into the aileron servo mount.
- 2) Secure the servos with the screws provided with your radio system.

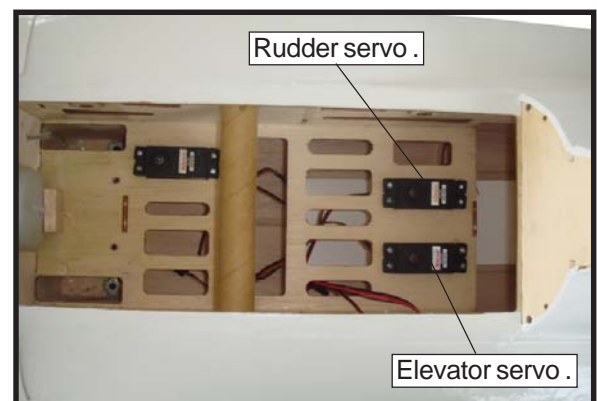

THROTTLE SERVO ARM INSTALLATION.

Install adjustable servo connector in the servo arm as same as picture below:

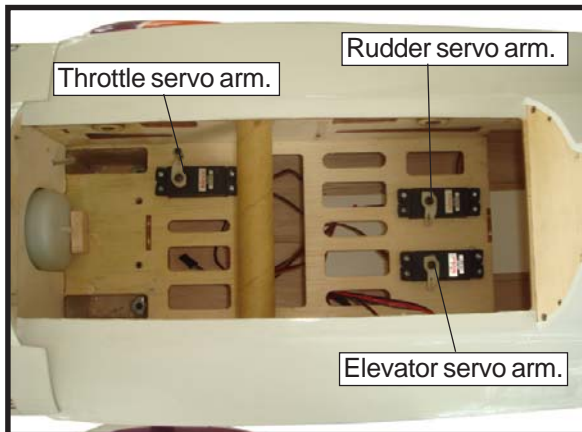
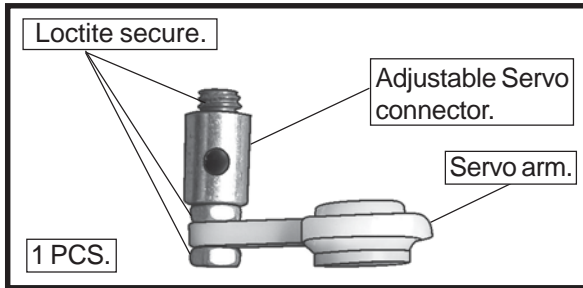

INSTALLING THE SWITCH.

Install the switch into the precut hole in the side of fuselage.

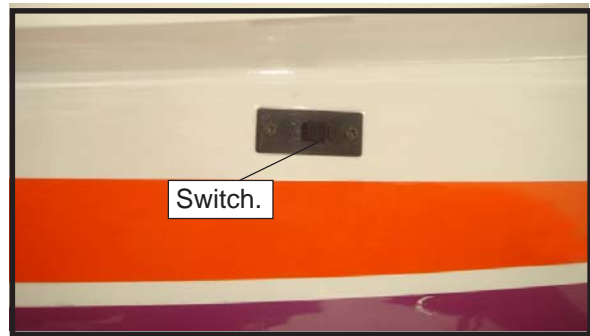
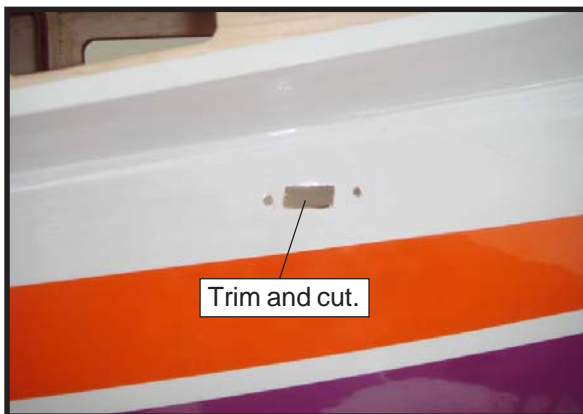

MOUNTING THE ENGINE.

+ ENGINE .61 - .75 : 2 STROKE.

□ 1) Position the engine with the drive washer (135mm) forward of the firewall as shown.

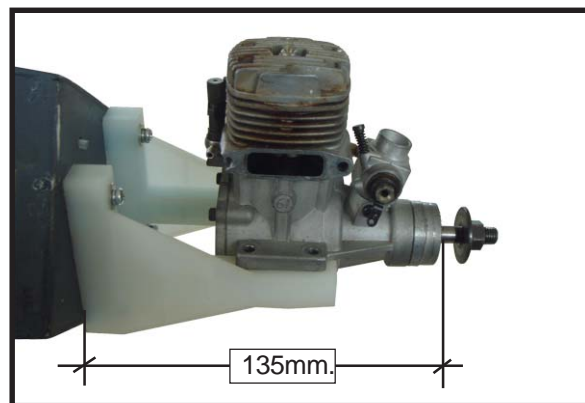

2) Use a pin drill and 3.5mm drill bit to drill a small indentation in the mount for the engine mounting screw.

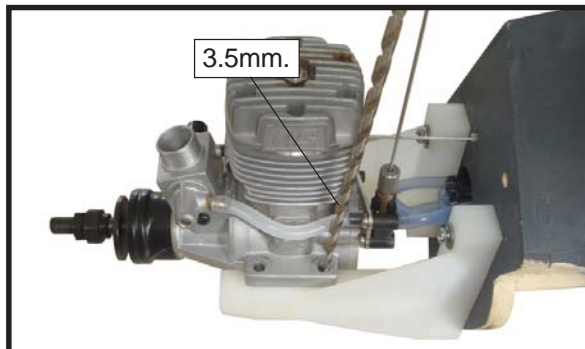

3) Use a drill to drill the four holes in the engine mount rails.

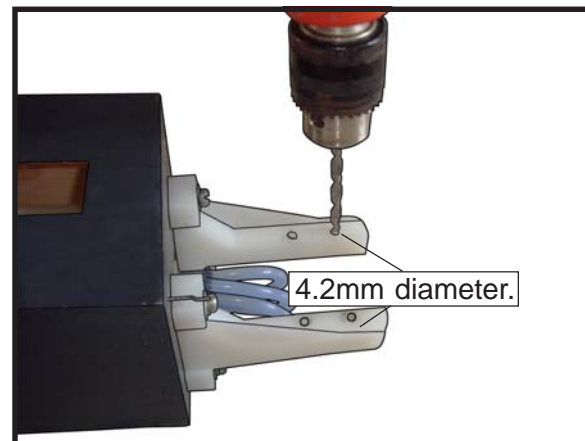

4) On the fire wall has the location for the throttle pushrod tube (pre-drill).



5) Slide the pushrod tube in the firewall and guide it through the fuel tank mount. Use medium C/A to glue the tube to the firewall and the fuel tank mount.

6) Connect the Z-bend in the 500mm throttle pushrod to the outer hole of the carburetor arm.

7) Slide the throttle pushrod wire into the tube. Position the engine between the mounts. Use four 4x30mm machine screws to secure the engine to the mount as shown.

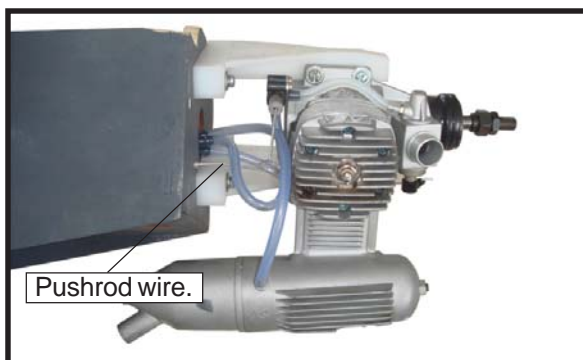
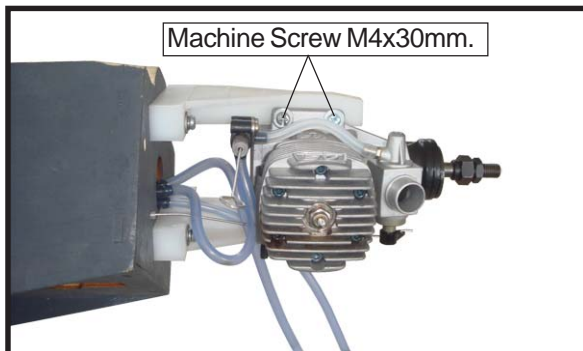

8) Reinstall the servo horn by sliding the connector over the pushrod wire. Center the throttle stick and trim and install the servo horn perpendicular to the servo center line.



9) Move the throttle stick to the closed position and move the carburetor to closed. Use a 2.5mm hex wrench to tighten the screw that secures the throttle pushrod wire. Make sure to use threadlock on the screw so it does not vibrate loose.

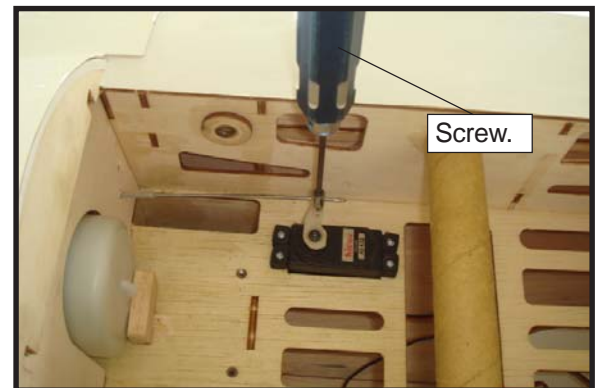

+ ENGINE .91 - 1.00 : 4 STROKE.

□ 1) Position the engine with the drive washer (115mm) forward of the firewall as shown.

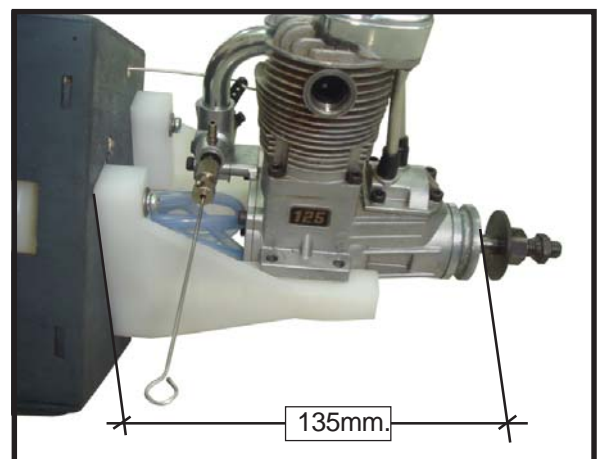

2) Use a pin drill and 3.5mm drill bit to drill a small indentation in the mount for the engine mounting screw.

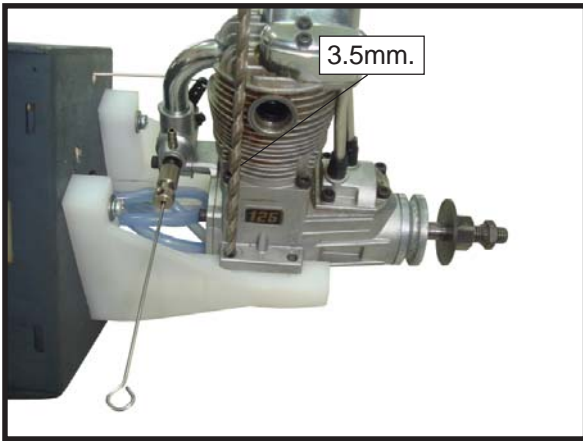

3) Use a drill to drill the four holes in the engine mount rails.

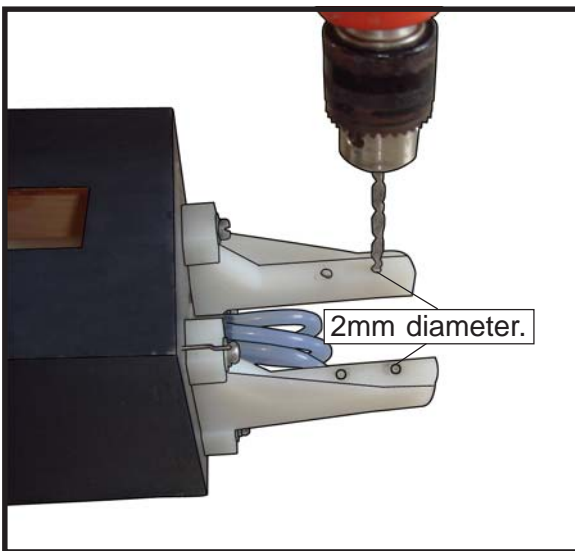

4) On the fire wall has the location for the throttle pusshrod tube (pre-drill).



5) Slide the pushrod tube in the firewall and guide it through the fuel tank mount. Use medium C/A to glue the tube to the firewall and the fuel tank mount.

6) Connect the Z-bend in the 500mm throttle pushrod to the outer hole of the carburetor arm.

7) Slide the throttle pushrod wire into the tube. Position the engine between the mounts. Use four 3x40mm machine screws to secure the engine to the mount as shown.

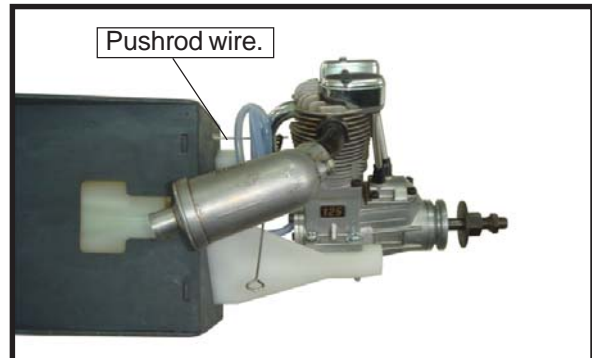
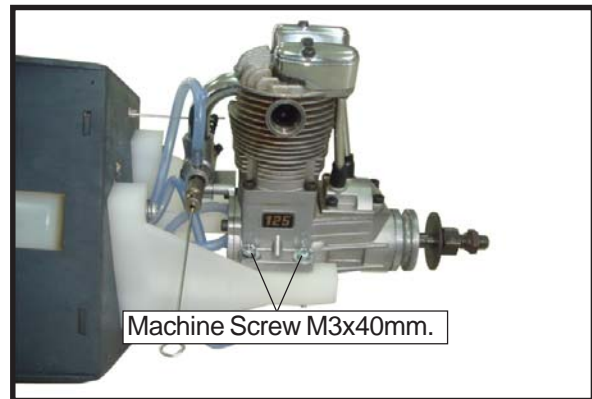

8) Reinstall the servo horn by sliding the connector over the pushrod wire. Center the throttle stick and trim and install the servo horn perpendicular to the servo center line.



9) Move the throttle stick to the closed position and move the carburetor to closed. Use a 2.5mm hex wrench to tighten the screw that secures the throttle pushrod wire. Make sure to use threadlock on the screw so it does not vibrate loose.



COWLING INSTALLATION.

□ 1) Slide the fiberglass cowl over the engine and line up the back edge of the cowl with the marks you made on the fuselage then trim and cut as shown.

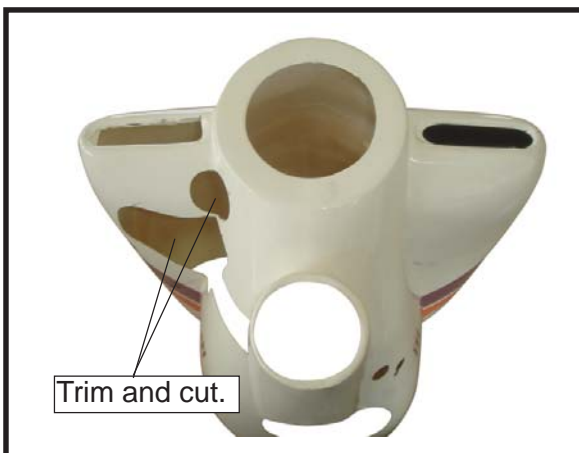
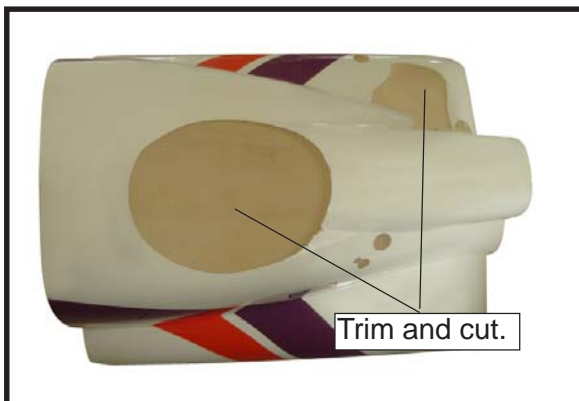

Because of the size of the cowl, it may be necessary to use a needle valve extension for the high speed needle valve. Make this out of sufficient length 1.5mm wire and install it into the end of the needle valve. Secure the wire in place by tightening the set screw in the side of the needle valve.

□ 2) While keeping the back edge of the cowl flush with the marks, align the front of the cowl with the crankshaft of the engine. The front of the cowl should be positioned so the crankshaft is in **nearly** the middle of the cowl opening. Use the spinner backplate as a guide. Hold the cowl firmly in place using pieces of masking tape.



□ 3) Install the muffler and muffler extension onto the engine and make the cutout in the cowl for muffler clearance. Connect the fuel and pressure lines to the carburetor, muffler and fuel filler valve. Secure the cowl to fuselage using the 3x10mm screws to tighten the screws.



ELECTRIC POWER CONVERSION.

1) Locate the items necessary to install the electric power conversion parts included with your model.

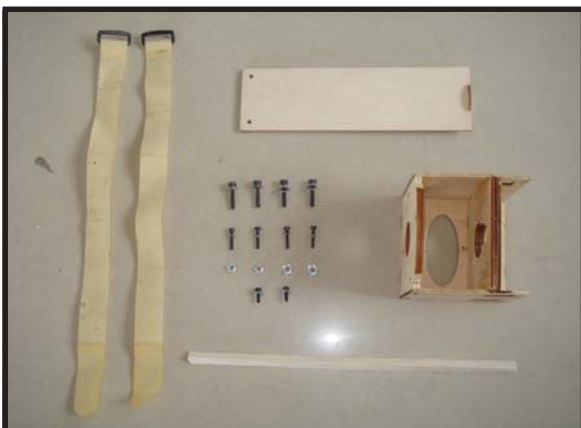

Recommendation EP parts as shown (not included with your model)

- Model size: .61-.75 size models
- Motor: 50mm 310 rev per volt
- Propeller: 13x10 ~ 14x10
- ESC: 60A
- Lipo Batteries: 8 cell 3200mA

2) Attach the electric motor box to the firewall suitable with the cross lines drawn on the electric motor box and firewall. Using epoxy and balsa stick to secure the motor box to the firewall. Please see pictures below.

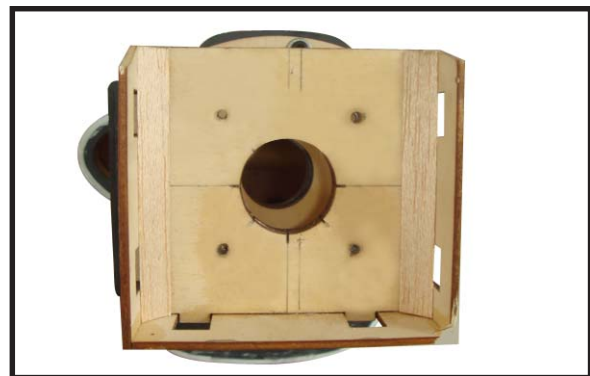
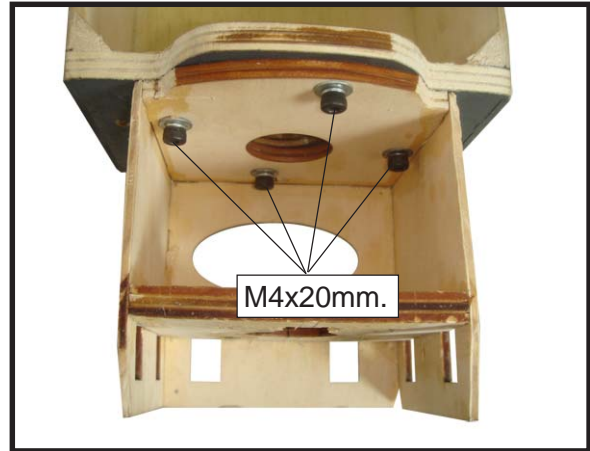

3) Attach the motor to the front of the electric motor box using four 4mm blind nut, four M4x20mm hex head bolts to secure the motor. Please see picture shown.

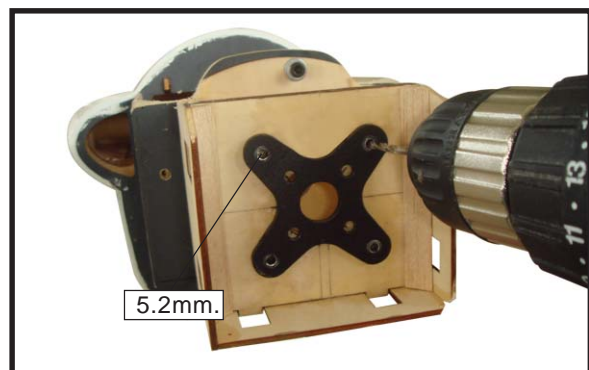

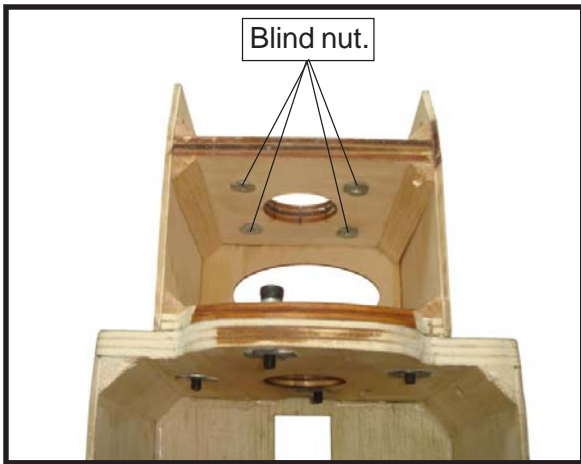

4) Locate the plywood battery tray to the fuselage. Tighten the screws using machine screws M3x15mm to secure the tray in position.

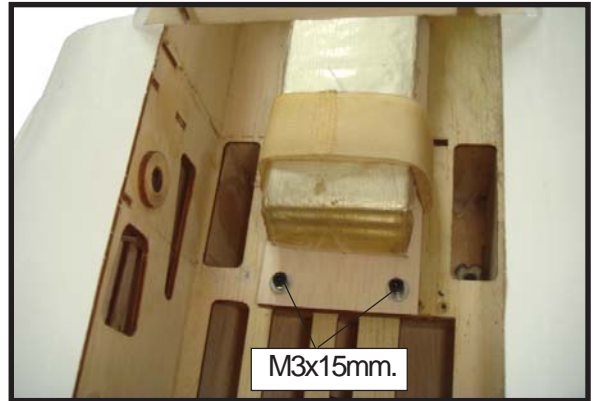
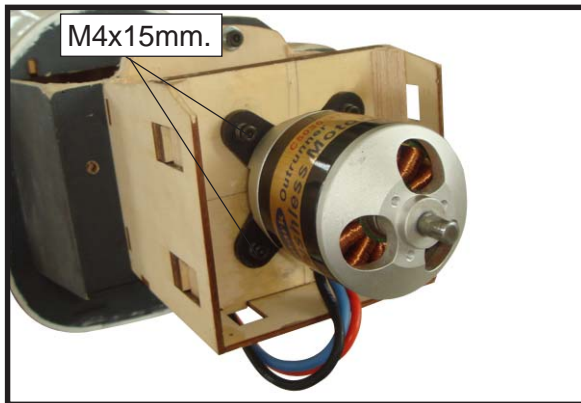

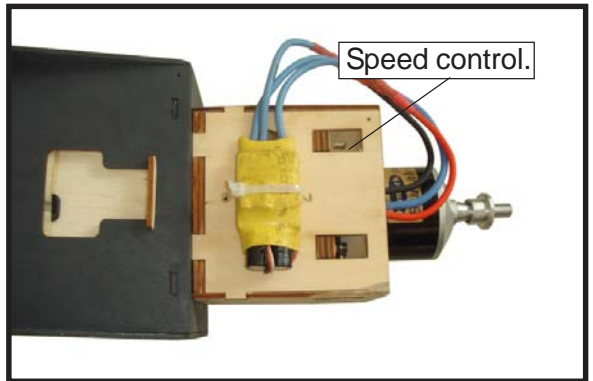
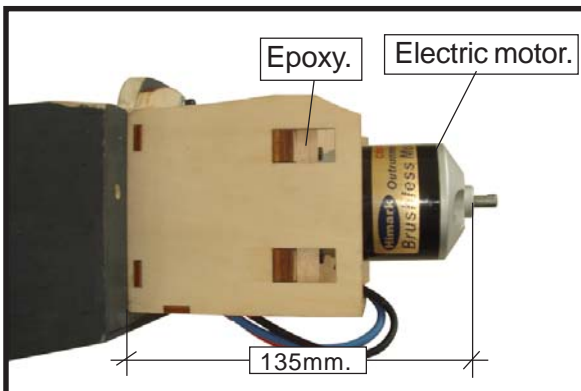

5) Attach the speed control to the side of the motor box using two-sided tape and tie wraps. Connect the appropriate leads from the speed control to the motor. Make sure the leads will not interfere with the operation of the motor.

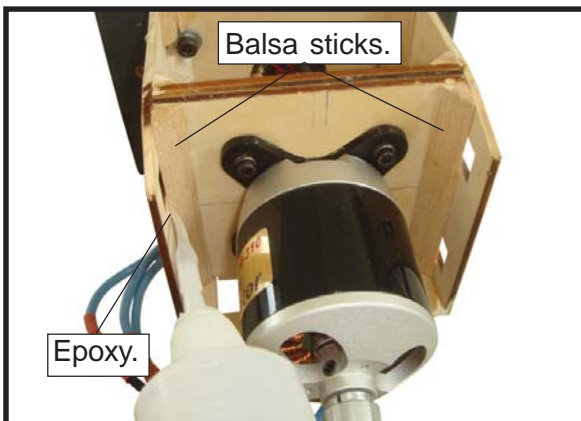

SPINNER INSTALLATION.

Install the spinner backplate, propeller and spinner cone.



 *The propeller should not touch any part of the spinner cone. If it does, use a sharp modeling knife and carefully trim away the spinner cone where the propeller comes in contact with it.*



AILERON PUSHROD HORN INSTALLATION

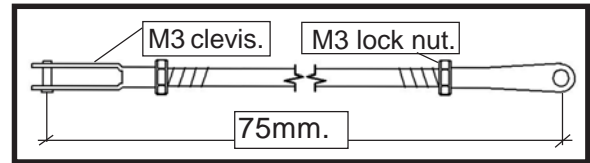
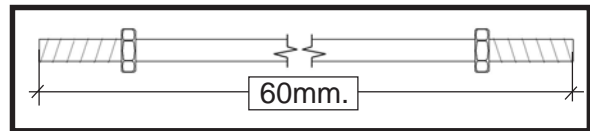

3) Connect the linkage as shown and secure the control wire with a snap keeper.

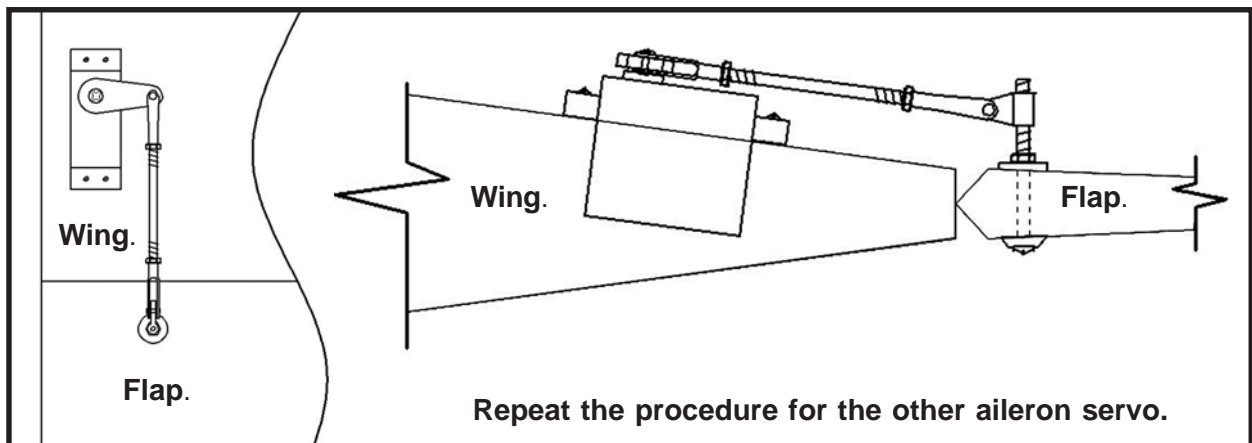
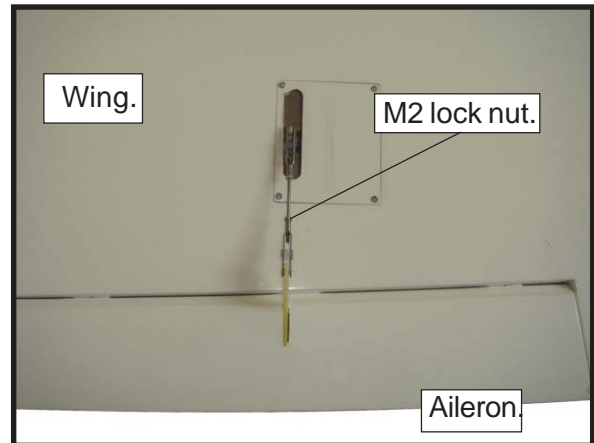

INSTALLING THE HORIZONTAL STABILIZER.

□ 1) Using a ruler and a pen, locate the centerline of the horizontal stabilizer, at the trailing edge, and place a mark. Use a triangle and extend this mark, from back to front, across the top of the stabilizer. Also extend this mark down the back of the trailing edge of the stabilizer.

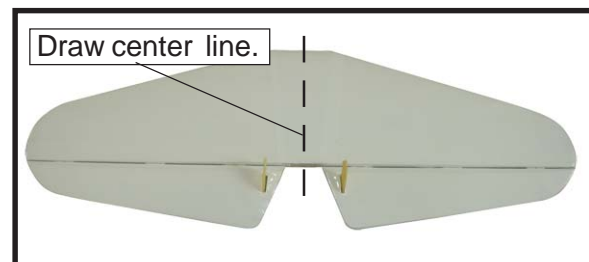

□ 2) Using a modeling knife, carefully remove the covering at mounting slot of horizontal stabilizer (both side of fuselage).

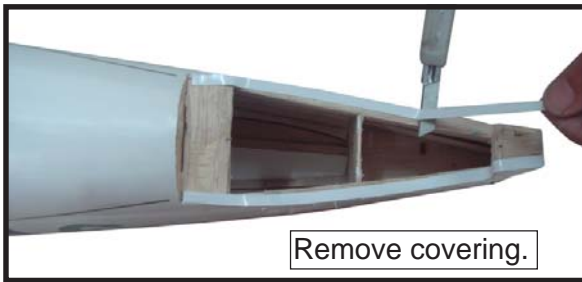

□ 3) Put the stabilizer into place in the position of the fuselage.

□ 4) Install the stabilizer onto the fuselage. Align the centerline drawn on the top and the rear of the stabilizer with the centre of the fuselage. When that is aligned, hold the stabilizer in that position using T-pins or masking tape. Align the horizontal stabilizer with the wing. When viewed from the rear, the horizontal stabilizer should be level with the wing. If it is not level, use sandpaper and sand down the high side of the stabilizer mounting platform until the proper alignment is achieved. The tips of the stabilizer should also be equal distance from the tips of the wing.

□ 5) When you are satisfied with the alignment, hold the stabilizer in place with T-pins or masking tape, but do not glue at this time.

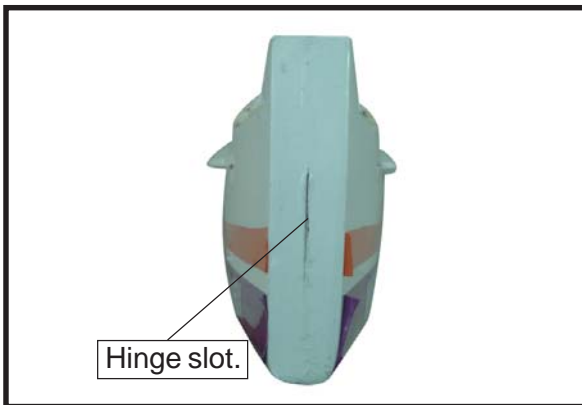

□ 6) With the stabilizer held firmly in place, use a pen and draw lines onto the stabilizer where it and the fuselage sides meet. Do this on both the right and left sides and top and bottom of the stabilizer.

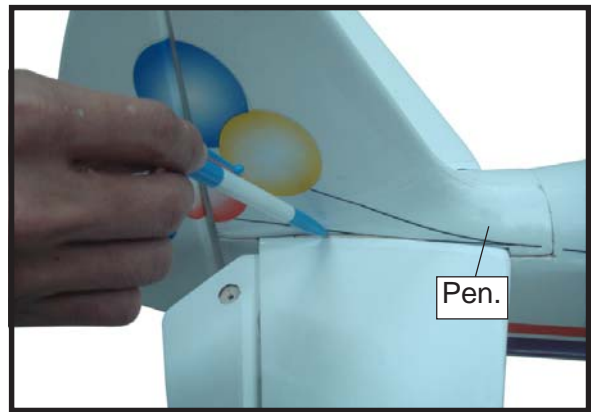

□ 7) Remove the stabilizer. Using the lines you just drew as a guide, carefully remove the covering from between them using a modeling knife.

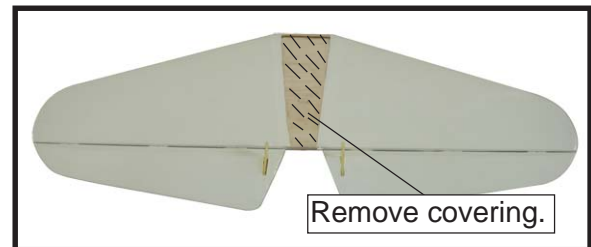

! *When cutting through the covering to remove it, cut with only enough pressure to only cut through the covering itself. Cutting into the balsa structure may weaken it.*

□ 8) Using a modeling knife, carefully remove the covering that overlaps the stabilizer mounting platform sides in the fuselage. Remove the covering from both the top and the bottom of the platform sides.

□ 9) When you are sure that everything is aligned correctly, mix up a generous amount of 30 Minute Epoxy. Apply a thin layer to the bottom of the stabilizer mounting area and to the stabilizer mounting platform sides in the fuselage. Putting the stabilizer in place and realign. Double check all of your measurements once more before the epoxy cures. Hold the stabilizer in place with T-pins or masking tape and remove any excess epoxy using a paper towel and rubbing alcohol.

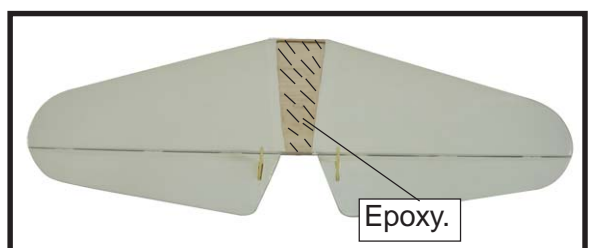

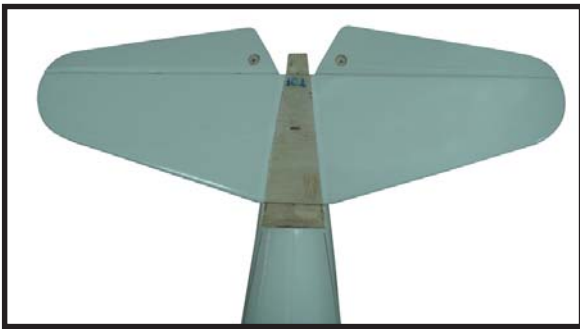

□ 10) After the epoxy has fully cured, remove the masking tape or T-pins used to hold the stabilizer in place. Carefully inspect the glue joints. Use more epoxy to fill in any gaps that may exist that were not filled previously and clean up the excess using a paper towel and rubbing alcohol.

INSTALLING THE VERTICAL STABILIZER.

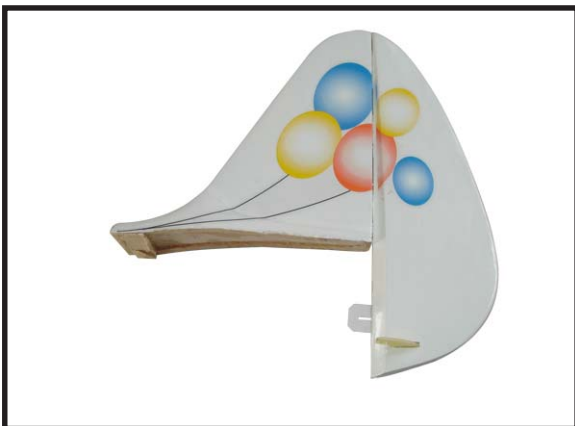

1) Using a modeling knife, remove the covering from over the precut hinge slot cut into the lower rear portion of the tail at the fuselage.

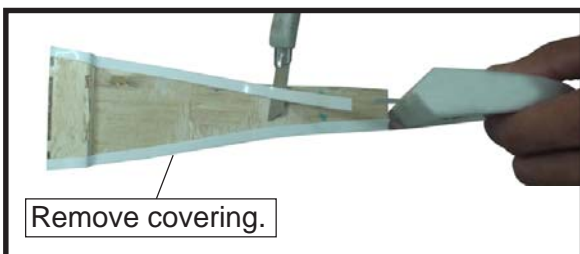

Remove covering.

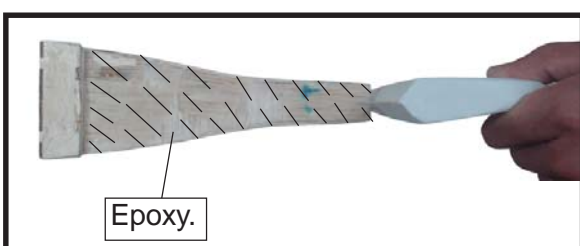

Epoxy.

2) While holding the vertical stabilizer firmly in place, use a pen and draw a line on each side of the vertical stabilizer where it meets the top of the fuselage.

3) Slide the vertical stabilizer back in place. Using a triangle, check to ensure that the vertical stabilizer is aligned 90° to the horizontal stabilizer.

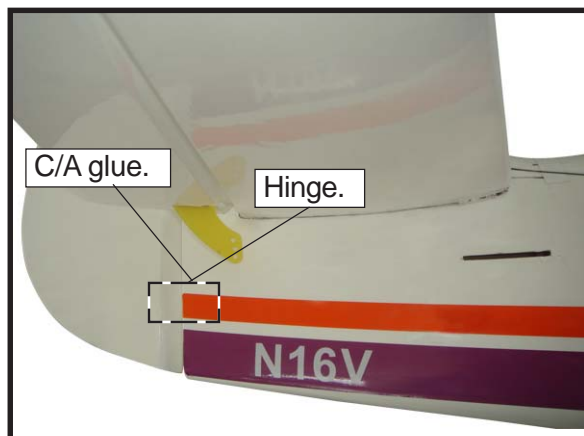
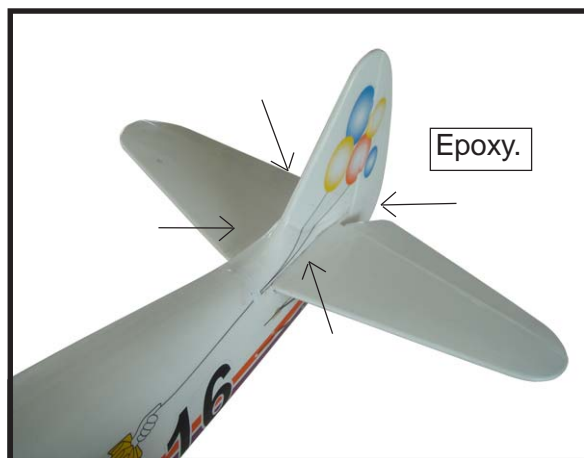
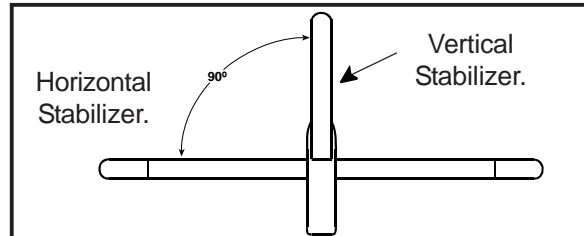

4) When you are sure that everything is aligned correctly, mix up a generous amount of Flash 30 Minute Epoxy. Apply a thin layer to the mounting slot and to bottom of the vertical stabilizer mounting area. Apply epoxy to the bottom and top edges of the filler block and to the lower hinge also. Set the stabilizer in place and realign. Double check all of your measurements once more before the epoxy cures. Hold the stabilizer in place with T-pins or masking tape and remove any excess epoxy using a paper towel and rubbing alcohol. Allow the epoxy to fully cure before proceeding.



ELEVATOR - RUDDER PUSHROD HORN INSTALLATION.

- 1) Install the elevator control horn using the same method as with the aileron control horns.
- 2) Position the elevator control horn on the both side of elevator.

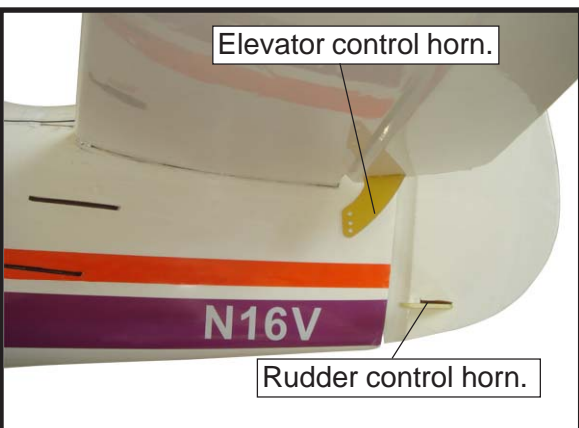

- 3) Thread one clevis and M2 lock nut on to each elevator control rod. Thread the horns on until they are flush with the ends of the control rods.
- 4) Elevator and rudder pushrods assembly as pictures below.

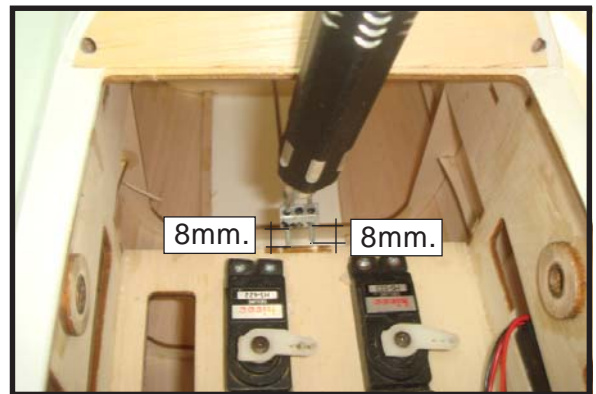
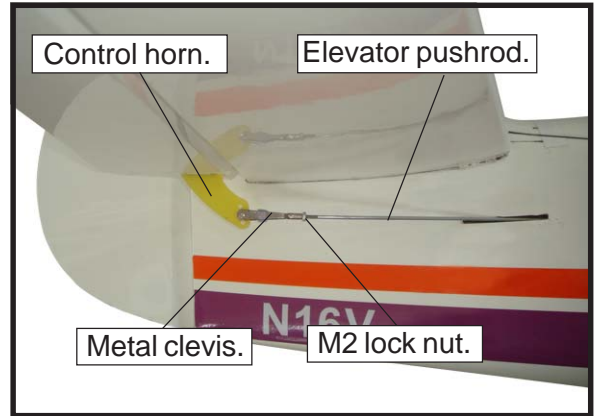
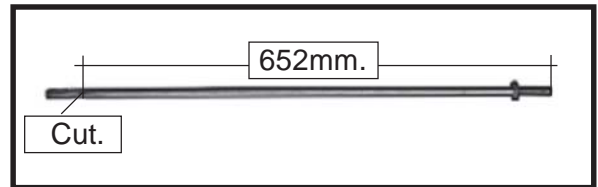

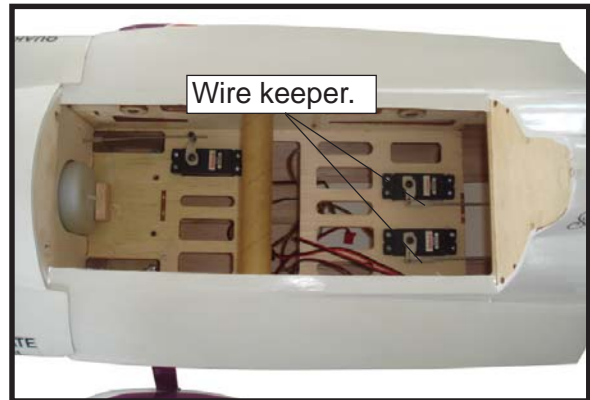
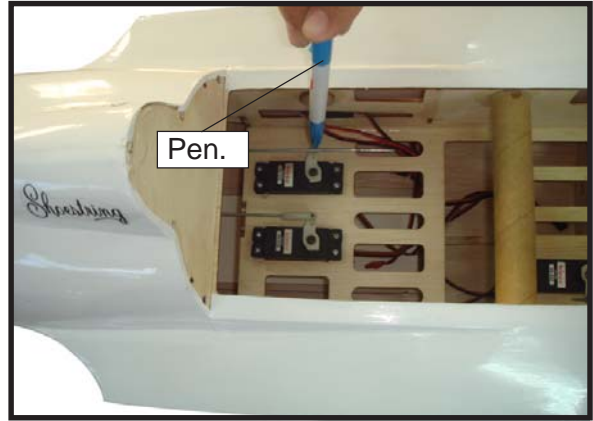
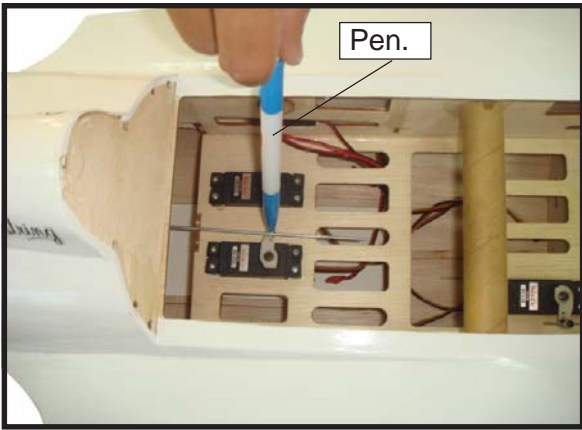

RUDDER PUSHROD HORN INSTALLATION.

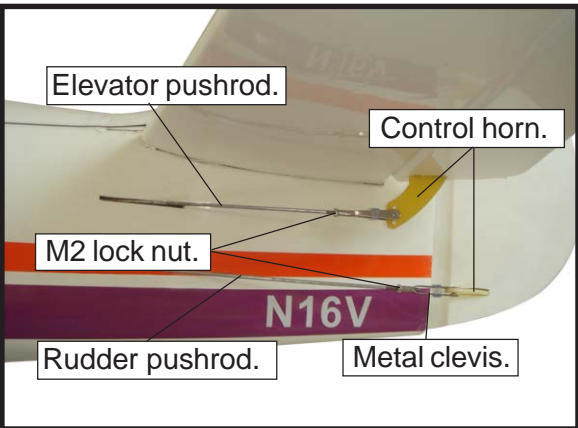
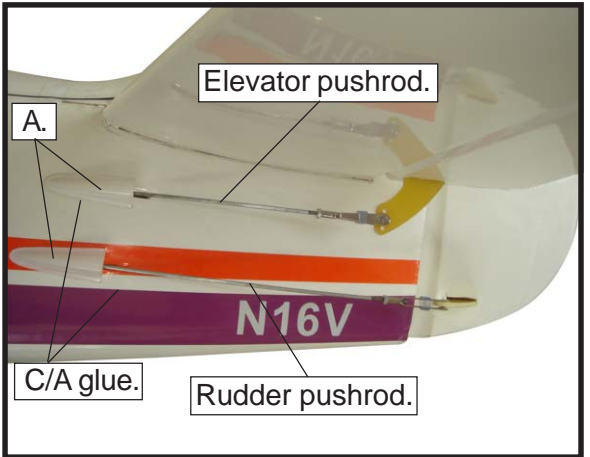
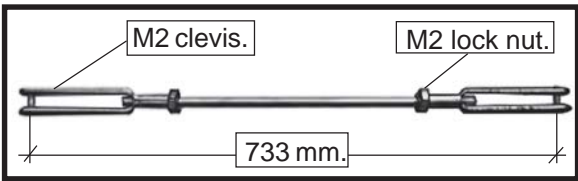
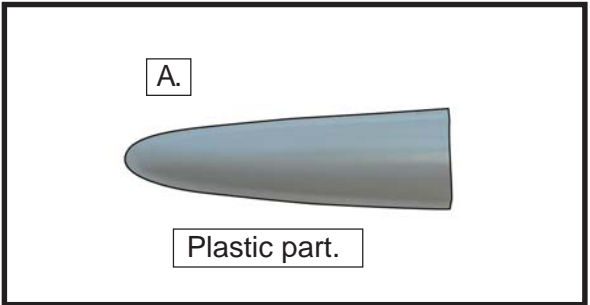
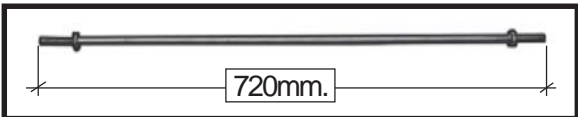

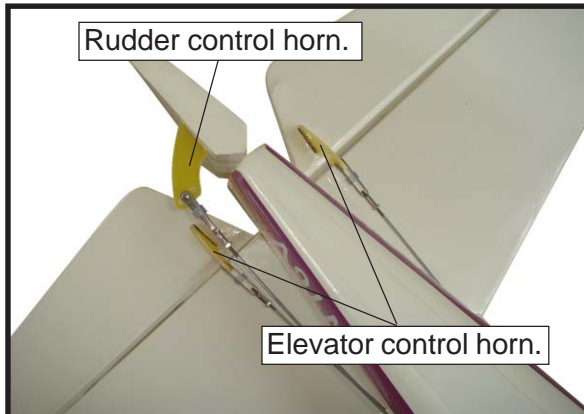
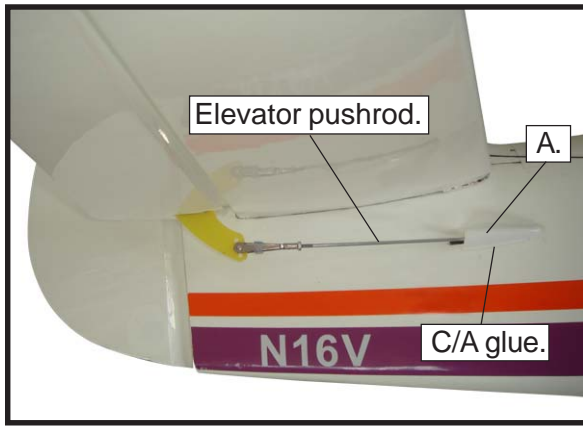

MOUNTING THE TAIL WHEEL.

See pictures below.

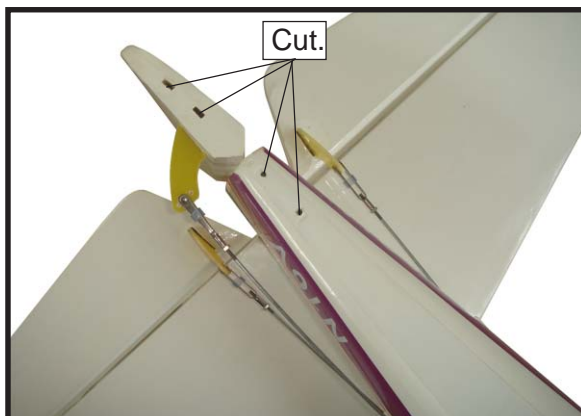
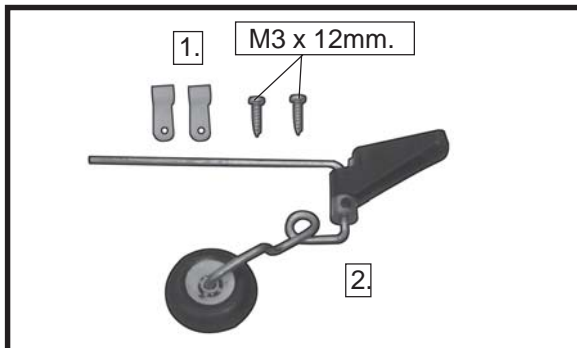

□ 1) Set the tail wheel assembly in place on the plywood plate. The pivot point of the tail wheel wire should be even with the rudder hinge line and the tail wheel bracket should be centered on the plywood plate.

□ 2) Using a pen, mark the locations of the two mounting screws. Remove the tail wheel bracket and drill 1mm pilot holes at the locations marked.

□ 3) Secure the tail wheel bracket in place using two 3mm x 12mm wood screws. Be careful not to overtighten the screws.

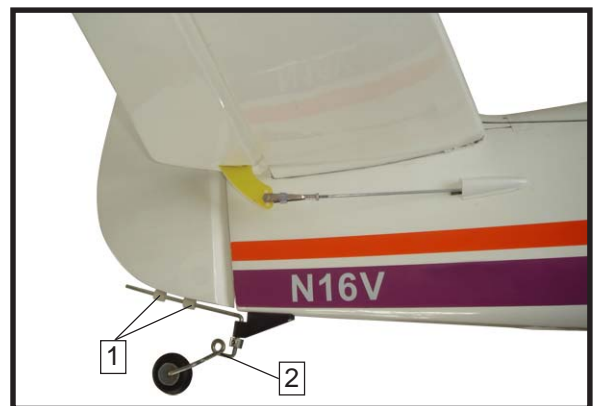
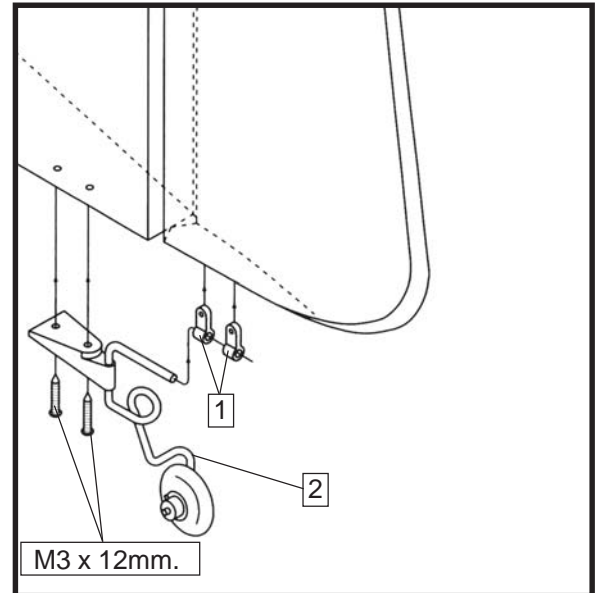

APPLY THE DECALS.

1) If all the decals are precut and ready to stick. Please be certain the model is clean and free from oily fingerprints and dust. Position decal on the model where desired, using the photos on the box and aid in their location.

2) If all the decals are not precut, please use scissors or a sharp hobby knife to cut the decals from the sheet. Please be certain the model is clean and free from oily fingerprints and dust. Position decal on the model where desired, using the photos on the box and aid in their location.

INSTALLING THE BATTERY-RECEIVER.

- 1) Plug the five servo leads and the switch lead into the receiver. Plug the battery pack lead into the switch also.
- 2) Wrap the receiver and battery pack in the protective foam rubber to protect them from vibration.
- 3) Route the antenna in the antenna tube inside the fuselage and secure it to the bottom of fuselage using a plastic tape.

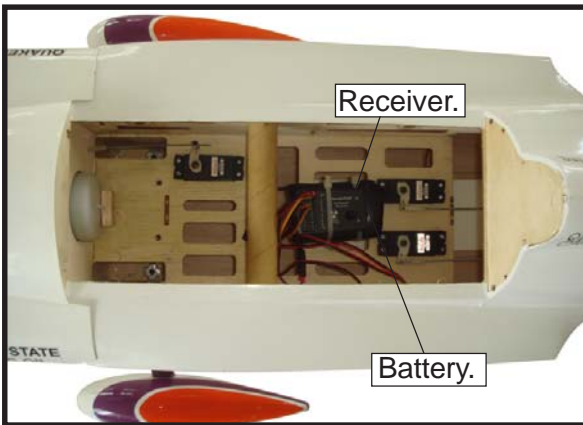

Attach the aluminium tube into fuselage.

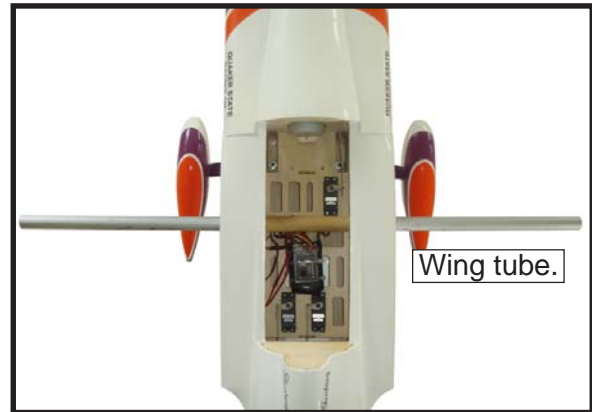

Insert two wing panels as pictures below.

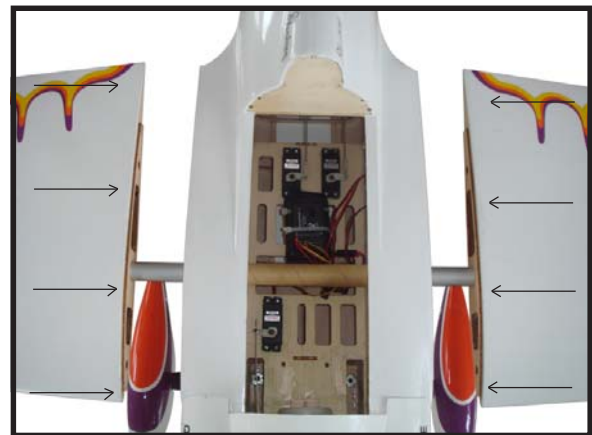

ATTACHMENT WING-FUSELAGE.

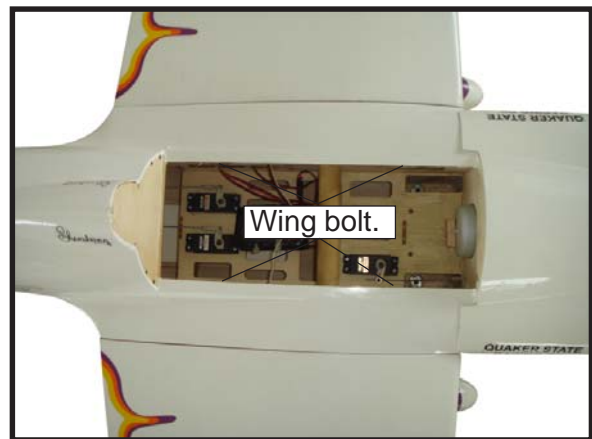



BALANCING.

□ 1) It is critical that your airplane be balanced correctly. Improper balance will cause your plane to lose control and crash. THE CENTER OF GRAVITY IS LOCATED **94 MM** BACK FROM THE LEADING EDGE OF THE WING AT THE WING ROOT.

□ 2) Mount the wing to the fuselage. Using a couple of pieces of masking tape, place them on the top side of the wing **94 mm** back from the leading edge of the wing at the wing root.

□ 3) Turn the airplane upside down. Place your fingers on the masking tape and carefully lift the plane .

Accurately mark the balance point on the top of the wing on both sides of the fuselage. The balance point is located **94 mm** back from the leading edge of the wing at the wing root. This is the balance point at which your model should balance for your first flights. Later, you may wish to experiment by shifting the balance up to 10mm forward or back to change the flying characteristics. Moving the balance forward may improve the smoothness and arrow- like tracking, but it may then require more speed for take off and make it more difficult to slow down for landing. Moving the balance aft makes the model more agile with a lighter and snappier "feel". In any case, please start at the location we recommend .

With the wing attached to the fuselage, all parts of the model installed (ready to fly), and empty fuel tanks, hold the model at the marked balance point with the stabilizer level.

Lift the model. If the tail drops when you lift, the model is "tail heavy" and you must add weight* to the nose. If the nose drops, it is "nose heavy" and you must add weight* to the tail to balance.

*If possible, first attempt to balance the model by changing the position of the receiver battery and receiver. If you are unable to obtain good balance by doing so, then it will be necessary to add weight to the nose or tail to achieve the proper balance point.

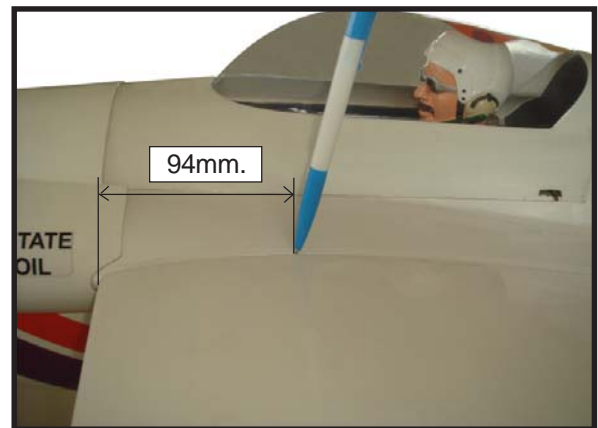

CONTROL THROWS.

Ailerons: 10mm low rate 12mm high rate.

Elevator: 10mm low rate 12mm high rate.

Rudder: 20mm low rate 30mm high rate.

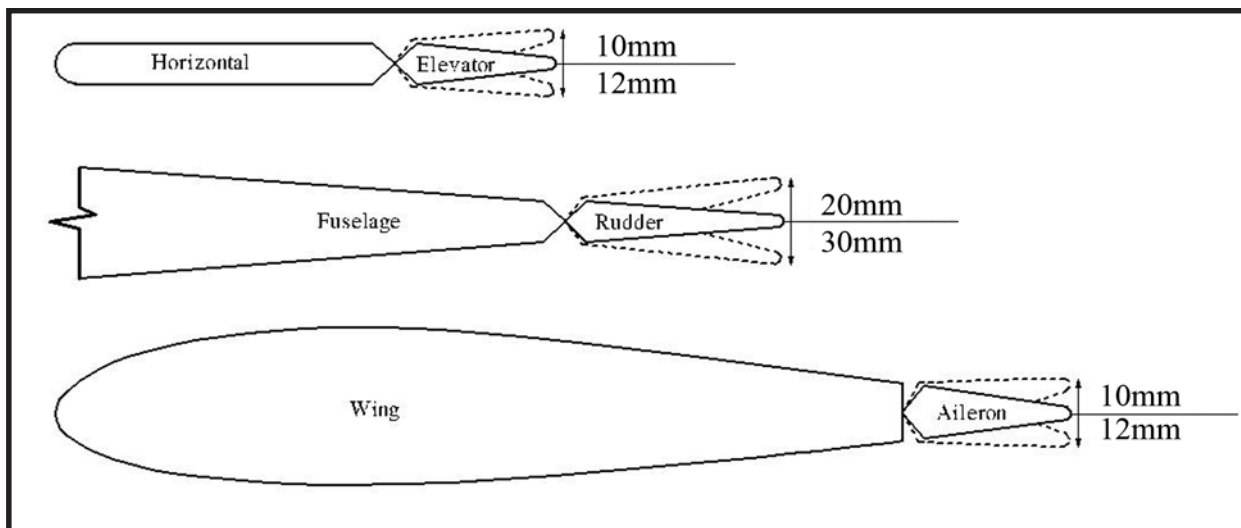

FLIGHT PREPARATION.

- A) Check the operation and direction of the elevator, rudder, ailerons and throttle.
- B) Plug in your radio system per the manufacturer's instructions and turn everything on.
- C) Check the elevator first. Pull back on the elevator stick. The elevator halves should move up. If they do not, flip the servo reversing switch on your transmitter to change the direction.
- D) Check the rudder. Looking from behind the airplane, move the rudder stick to the right. The rudder should move to the right. If it does not, flip the servo reversing switch on your transmitter to change the direction.
- E) Check the throttle. Moving the throttle stick forward should open the carburetor barrel. If it does not, flip the servo reversing switch on your transmitter to change the direction.
- F) From behind the airplane, look at the aileron on the right wing half. Move the aileron stick to the right. The right aileron should move up and the other aileron should move down. If it does not, flip the servo reversing switch on your transmitter to change the direction.

PREFLIGHT CHECK.

- 1) Completely charge your transmitter and receiver batteries before your first day of flying.
- 2) Check every bolt and every glue joint in the **SHOETRING** to ensure that everything is tight and well bonded.
- 3) Double check the balance of the airplane. Do this with the fuel tank empty.
- 4) Check the control surfaces. All should move in the correct direction and not bind in any way.
- 5) If your radio transmitter is equipped with dual rate switches double check that they are on the low rate setting for your first few flights.
- 6) Check to ensure the control surfaces are moving the proper amount for both low and high rate settings.
- 7) Check the receiver antenna. It should be fully extended and not coiled up inside the fuselage.
- 8) Properly balance the propeller. An out of balance propeller will cause excessive vibration which could lead to engine and/or airframe failure.

We wish you many safe and enjoyable flights with your SHOETRING.