

SPACE WALKER II

MS: X13

ALMOST READY TO FLY

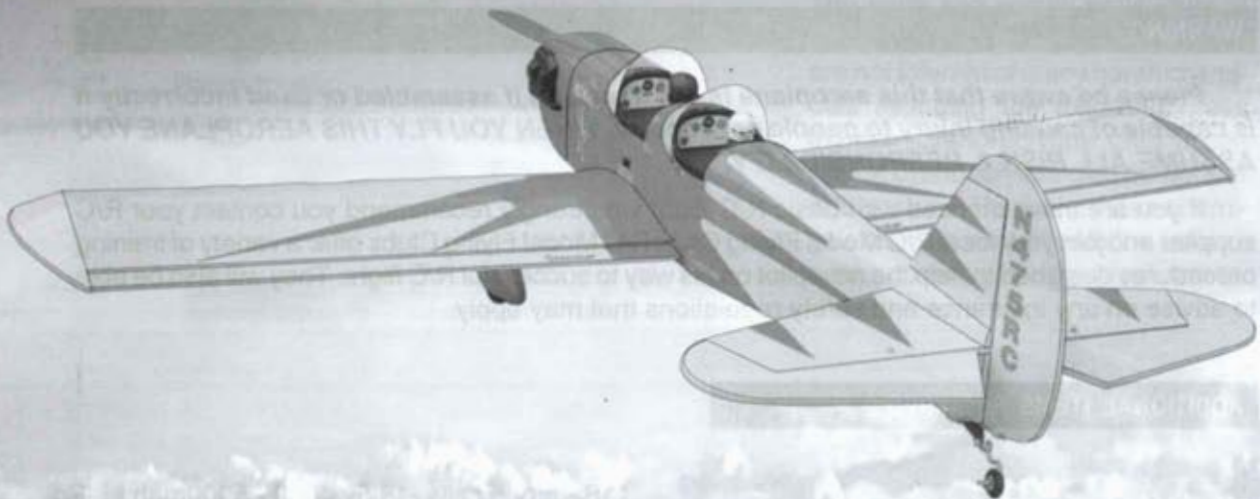

"Graphics and specifications may change without notice".

Specifications

Wingspan-----	62.2in-----	158cm.
Wing area-----	635.5 sq.in-----	41 sq.dm. ²
Approximate flying weight-----	4.4 - 5.7lbs-----	2.0- 2.6kg.
Length-----	45.7in-----	116cm.
Radio-----		4 channels.
5digital servos (size 24x12mm) Output Torque =1.8 - 2.2 kg - cm.		

Need to Complete

Speed Control: 80 - 100 amp.

Recommended Battery 5-cells 18.5V 4000mAh to 5000mAh Li-Po.

Kit features

- Ready-made—minimal assembly & finishing required.
- Ready-covered covering.
- Photo-illustrated step-by-step Assembly Manual.

Made in Vietnam.

INTRODUCTION.

Thank you for choosing the **SPACE WALKER II** ARTF . The **SPACE WALKER II** was designed with the intermediate/advanced sport flyer in mind. It is a scale airplane which is easy to fly and quick to assemble. The airframe is conventionally built using balsa, plywood to make it stronger than the average ARTF , yet the design allows the aeroplane to be kept light. You will find that most of the work has been done for you already. The motor mount has been fitted and the hinges are pre-installed . Flying the **SPACE WALKER II** is simply a joy.

This instruction manual is designed to help you build a great flying aeroplane. Please read this manual thoroughly before starting assembly of your **SPACE WALKER II**. Use the parts listing below to identify all parts.

WARNING.

Please be aware that this aeroplane is not a toy and if assembled or used incorrectly it is capable of causing injury to people or property. WHEN YOU FLY THIS AEROPLANE YOU ASSUME ALL RISK & RESPONSIBILITY.

If you are inexperienced with basic R/C flight we strongly recommend you contact your R/C supplier and join your local R/C Model Flying Club. R/C Model Flying Clubs offer a variety of training procedures designed to help the new pilot on his way to successful R/C flight. They will also be able to advise on any insurance and safety regulations that may apply.

ADDITIONAL ITEMS REQUIRED.

Motor:



Battery:5 cells -18.5v 4000 - 5000mah Li -Po

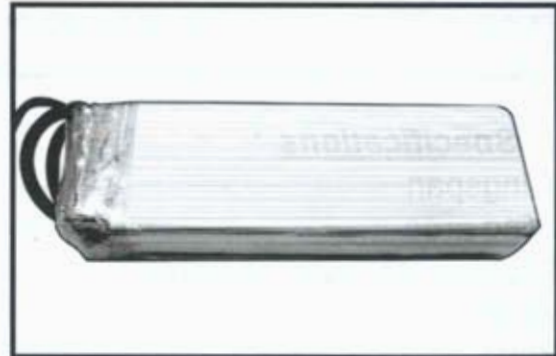

Speed control: 80A to 100A.

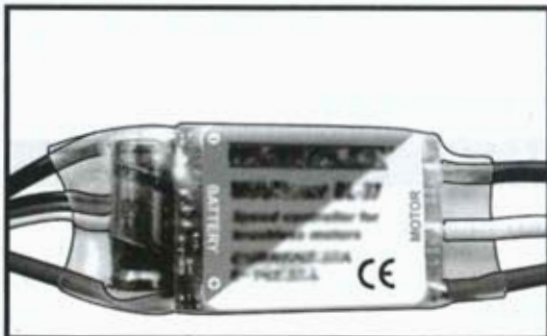

Radio with five digital servos.
Size = 24 x 12 MM
Torque = 1.8 - 2.2 kg - cm.

TOOLS & SUPPLIES NEEDED.

- Thick cyanoacrylate glue.
- 30 minute epoxy.
- 5 minute epoxy.
- Hand or electric drill.
- Assorted drill bits.
- Modelling knife.
- Straight edge ruler.
- 2mm ball driver.
- Phillips head screwdriver.
- 220 grit sandpaper.
- 90° square or builder's triangle.
- Wire cutters.
- Masking tape & T-pins.
- Thread-lock.
- Paper towels.

NOTE: To avoid scratching your new aeroplane we suggest that you cover your workbench with an old towel. Keep a couple of jars or bowls handy to hold the small parts after you open the bags.

Please trial fit all parts. Make sure you have the correct parts and that they fit and are aligned properly before gluing! This will ensure proper assembly as the **SPACE WALKER II** is made from natural materials and minor adjustments may have to be made.

The paint and plastic parts used in this kit are fuel proof. However, they are not tolerant of many harsh chemicals including the following: paint thinner, cyano-acrylate glue accelerator, cyanoacrylate glue de-bonder and acetone. Do not let these chemicals come in contact with the colours on the covering and the plastic parts.

HINGING THE AILERONS.

Note: The control surfaces, including the ailerons, elevators, and rudder, are prehinged with hinges installed, but the hinges are not glued in place. It is imperative that you properly adhere the hinges in place per the steps that follow using a high-quality thin C/A glue.

□ 1) Carefully remove the aileron from one of the wing panels. Note the position of the hinges.

□ 2) Remove each hinge from the wing panel and aileron and place a T-pin in the center of each hinge. Slide each hinge into the wing panel until the T-pin is snug against the wing panel. This will help ensure an equal amount of hinge is on either side of the hinge line when the aileron is mounted to the aileron.

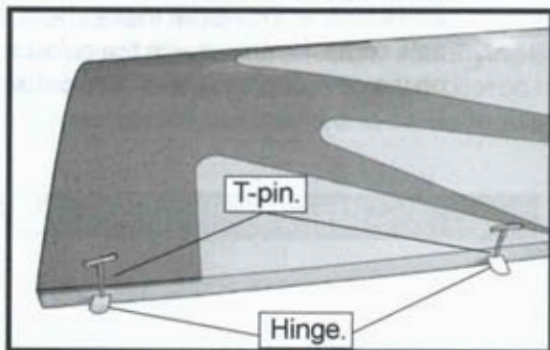

□ 3) Slide the wing panel on the aileron until there is only a slight gap. The hinge is now centered on the wing panel and aileron. Remove the T-pins and snug the aileron against the wing panel. A gap of 1/64" or less should be maintained between the wing panel and aileron.

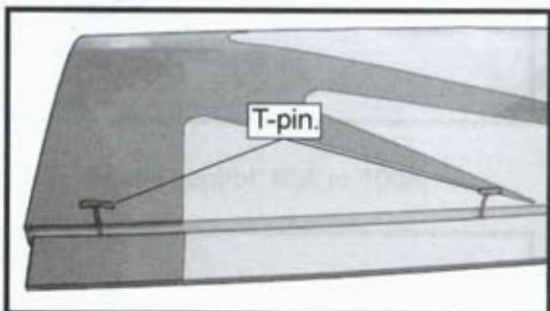

□ 4) Deflect the aileron and completely saturate each hinge with thin C/A glue. The aileron's front surface should lightly contact the wing during this procedure. Ideally, when the hinges are glued in place, a 1/64" gap or less will be maintained throughout the length of the aileron to the wing panel hinge line.

Note: The hinge is constructed of a special material that allows the C/A to wick or penetrate and distribute throughout the hinge, securely bonding it to the wood structure of the wing panel and aileron.

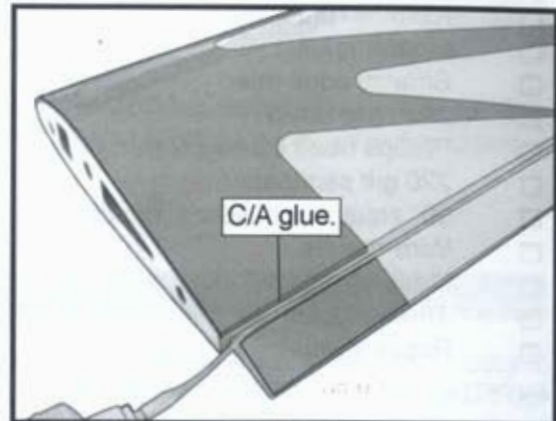

□ 5) Turn the wing panel over and deflect the aileron in the opposite direction from the opposite side. Apply thin C/A glue to each hinge, making sure that the C/A penetrates into both the aileron and wing panel.

□ 6) Using C/A remover/debonder and a paper towel, remove any excess C/A glue that may have accumulated on the wing or in the aileron hinge area.

□ 7) Repeat this process with the other wing panel, securely hinging the aileron in place.

□ 8) After both ailerons are securely hinged, firmly grasp the wing panel and aileron to make sure the hinges are securely glued and cannot be pulled out. Do this by carefully applying medium pressure, trying to separate the aileron from the wing panel. Use caution not to crush the wing structure.

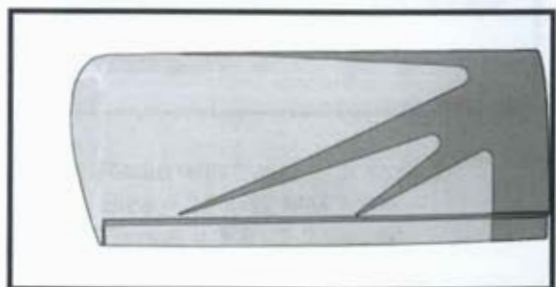

Note: Work the aileron up and down several times to "work in" the hinges and check for proper movement.

HINGING THE ELEVATOR.

Glue the elevator hinges in place using the same techniques used to hinge the ailerons.

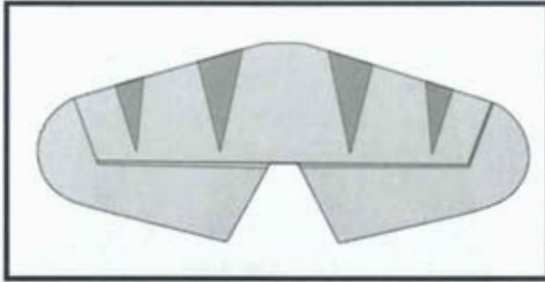

TURNBUCKLE INSTALLATION.



The hole location of turnbuckles shown in picture below .

 *The mounting holes of turnbuckle was pre-drilled at factory.*

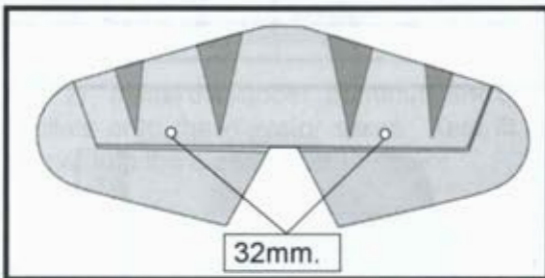

Installing the turnbuckle for tail strut of horizontal fin as same as pictures below.

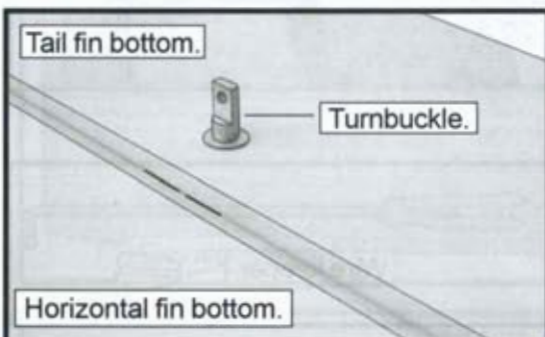

HINGING THE RUDDER.

Glue the rudder hinges in place using the same techniques used to hinge the ailerons.

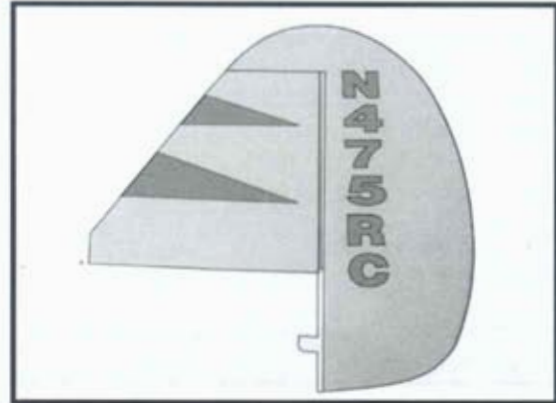

AILERON SERVOS.

1) Install the rubber grommets and brass collets onto the aileron servo. Test fit the servo into the aileron servo mount.

 *Because the size of servos differ, you may need to adjust the size of the pre-cut opening in the mount. The notch in the sides of the mount allow the servo lead to pass through.*

Attach the thread to the servo lead and carefully thread it though the wing.

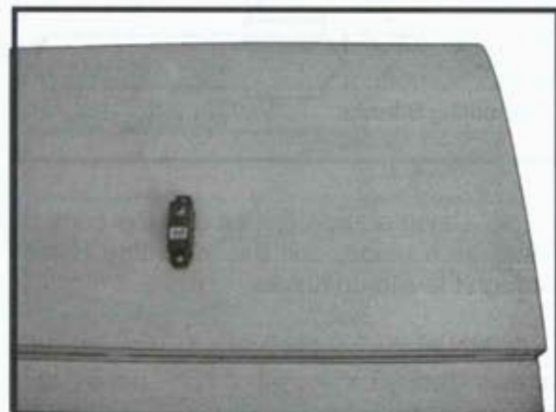
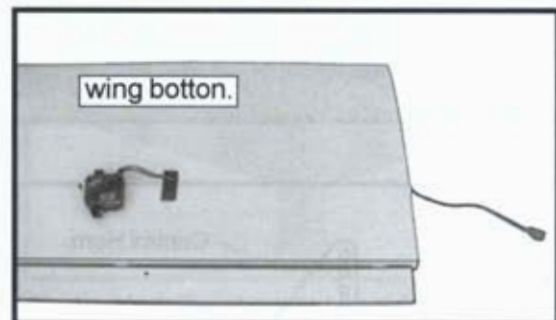

2) Secure the servos with the screws provided with your radio system.

AILERON LINKAGE.

1) Using a ruler & pen to draw a straight line as picture below.

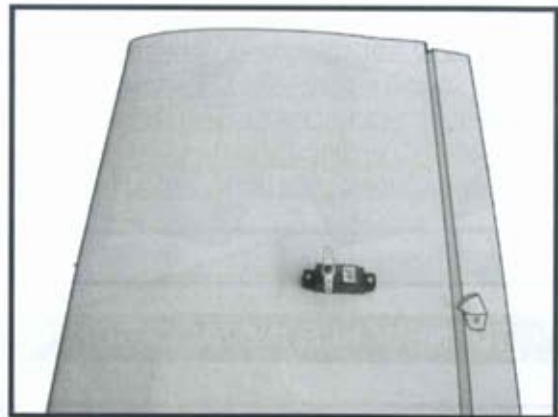
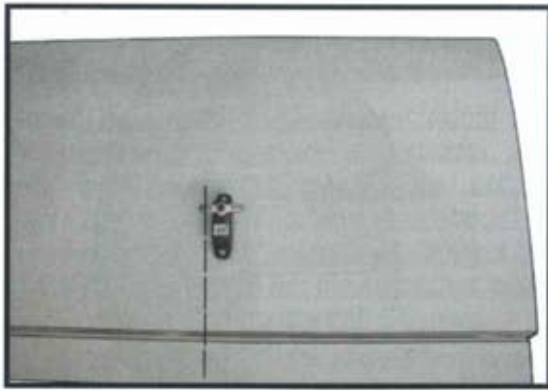

2) Locate the two nylon control horns, two nylon control horn backplates and four machine screws.

3) Position the aileron horn on the bottom side of aileron. The clevis attachment holes should be positioned over the hinge line.

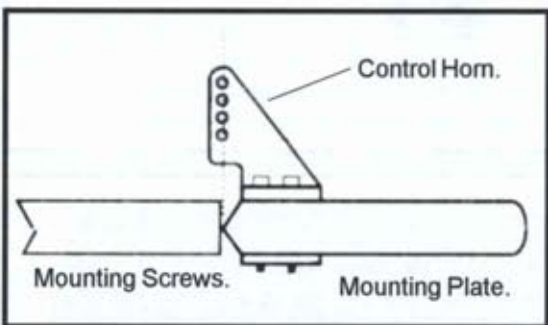
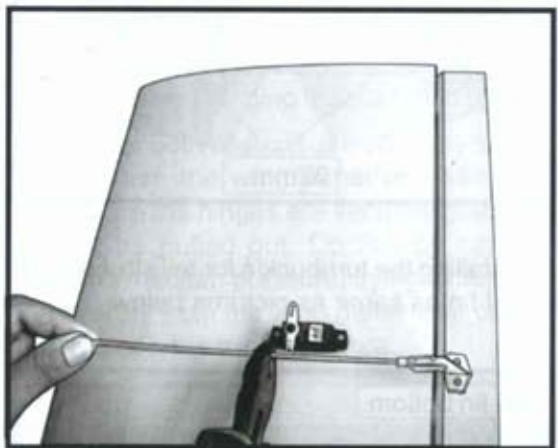
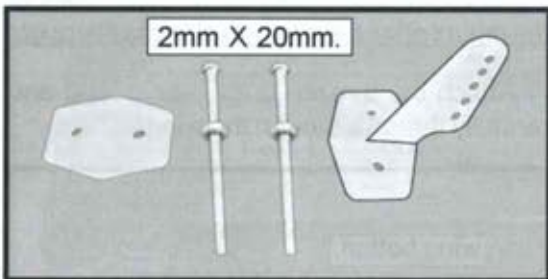
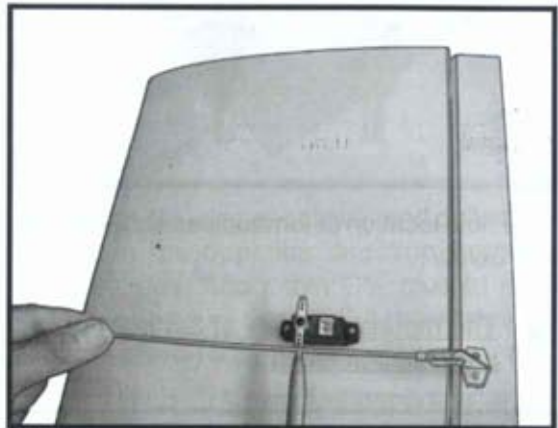

4) Using a 1mm drill bit and the control horns as a guide, drill the mounting holes through the aileron halves.

5) Mount the control horns by inserting the screws through the control horn bases and aileron halves, then into the mounting backplates. Do not overtighten the screws or the backplates may crush the wood.

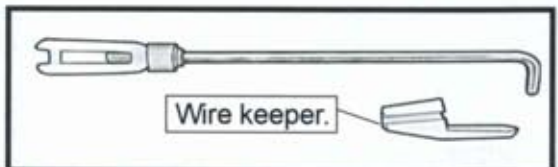

6) Connect the linkage as shown and secure the control wire with a wire keeper.

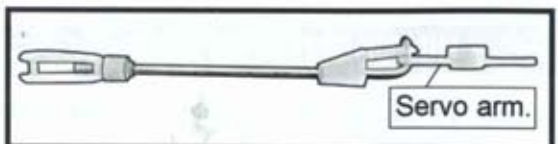

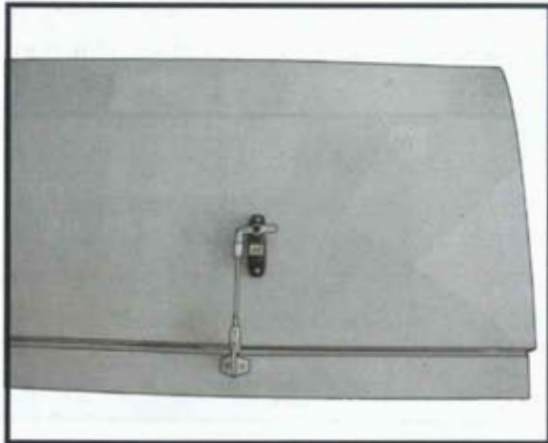

Repeat the procedure for the other aileron servo.

FUSELAGE SERVO INSTALLATION.

□ 1) Locate and cut out the covering film from the servo holes in both sides of fuselage.

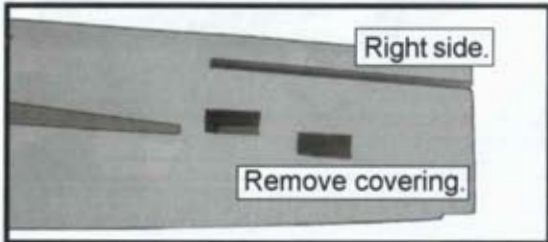

□ 2) Install the rubber grommets and brass collets onto the elevator servo. Test fit the servo into the elevator servo mount.

⚠ *Because the size of servos differ, you may need to adjust the size of the pre-cut opening in the mount. The notch in the sides of the mount allow the servo lead to pass through.*

□ 3) Secure the servos with the screws provided with your radio system.

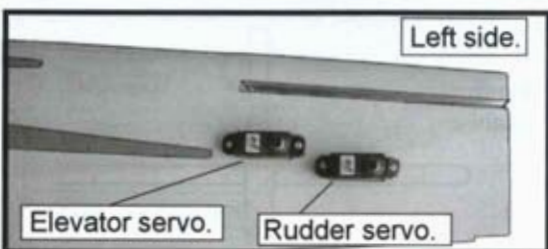
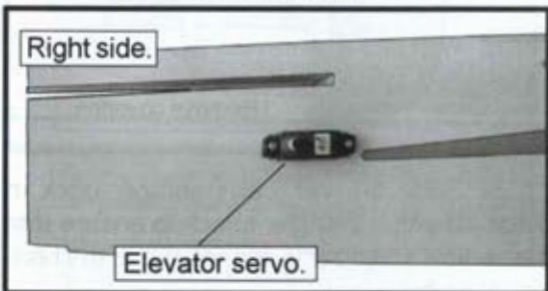

HORIZONTAL STABILIZER.

□ 1) Using a ruler and a pen, locate the centerline of the horizontal stabilizer, at the trailing edge, and place a mark. Use a triangle and extend this mark, from back to front, across the top of the stabilizer. Also extend this mark down the back of the trailing edge of the stabilizer.

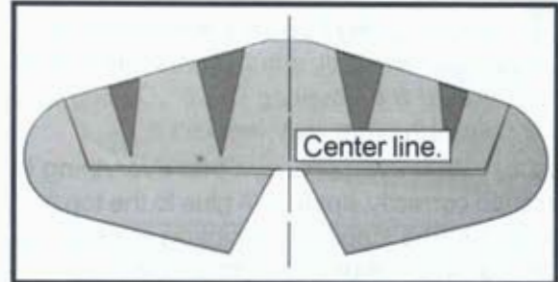

□ 2) Using a modeling knife, carefully remove the covering at mounting slot of horizontal stabilizer (both side of fuselage).

□ 3) Slide the stabilizer into place in the pre-cut slot in the rear of the fuselage. The stabilizer should be pushed firmly against the front of the slot.

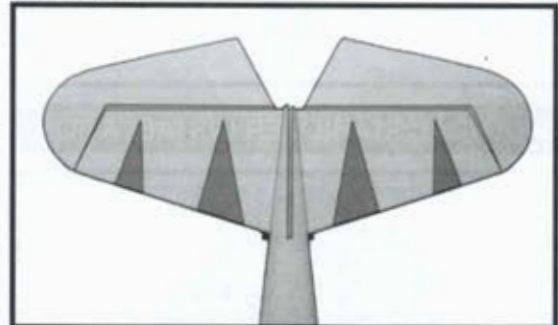

□ 4) With the stabilizer held firmly in place, use a pen and draw lines onto the stabilizer where it and the fuselage sides meet. Do this on both the right and left sides and top and bottom of the stabilizer.

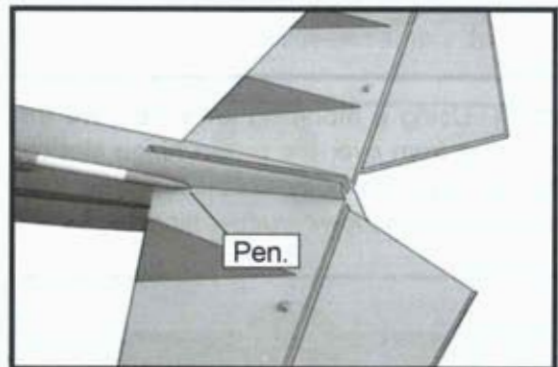

□ 5) Remove the stabilizer. Using the lines you just drew as a guide, carefully remove the covering from between them using a modeling knife.

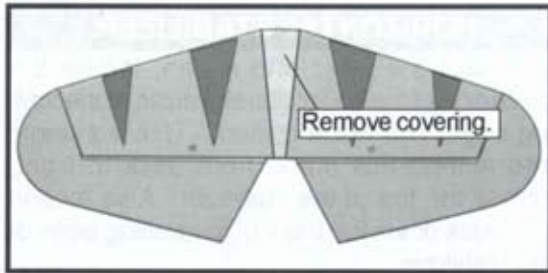

! When cutting through the covering to remove it, cut with only enough pressure to only cut through the covering itself. Cutting into the balsa structure may weaken it.

□ 6) When you are sure that everything is aligned correctly, apply C/A glue to the top and bottom of the stabilizer mounting area and to the stabilizer mounting platform sides.

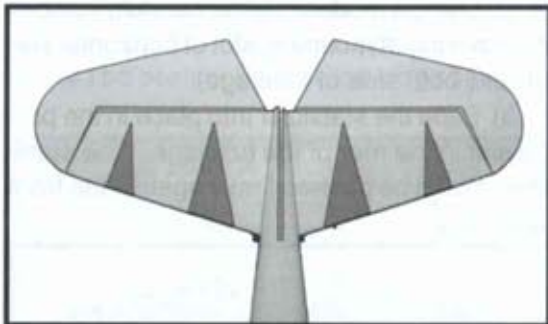

VERTICAL STABILIZER INSTALLATION.

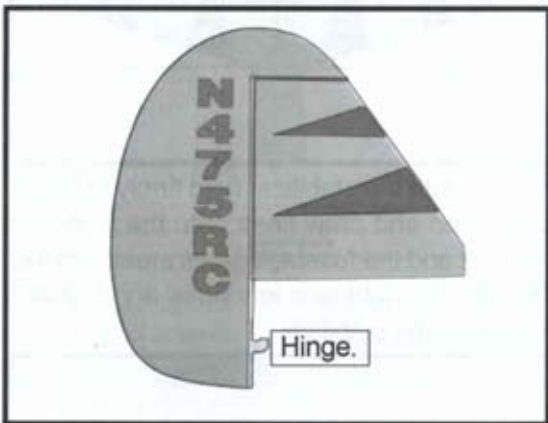

□ 1) Using a modeling knife, remove the covering from over the pre-cut hinge slot cut into the lower rear portion of the fuselage. This slot accepts the lower rudder hinge.

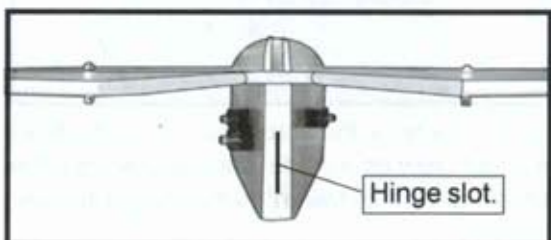

□ 2) Glue the vertical fin in place using same as techniques used to installing the horizontal fin.

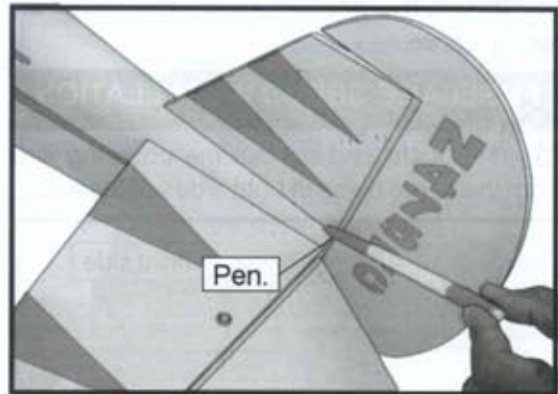
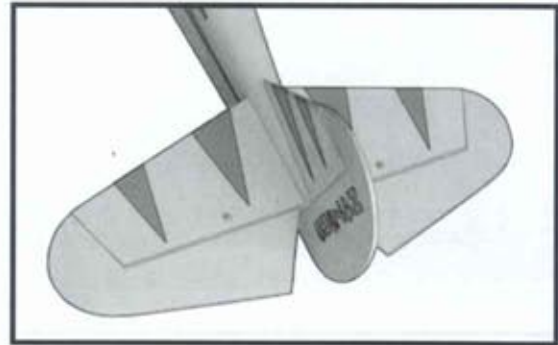

! When cutting through the covering to remove it, cut with only enough pressure to only cut through the covering itself. Cutting into the balsa structure may weaken it.

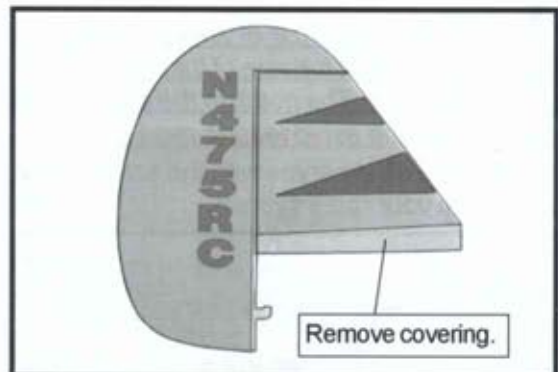

□ 3) Slide the vertical stabilizer back in place. Using a triangle, check to ensure that the vertical stabilizer is aligned 90° to the horizontal stabilizer.

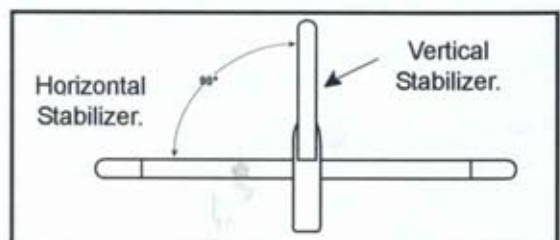

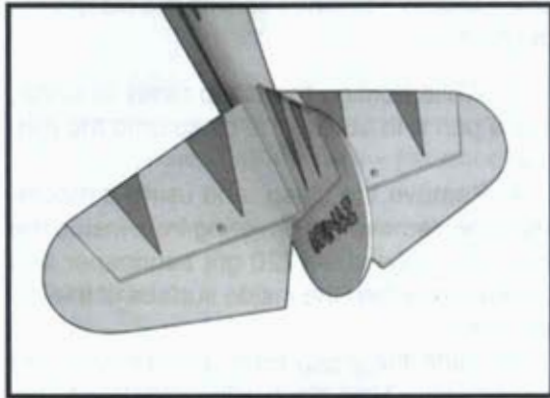
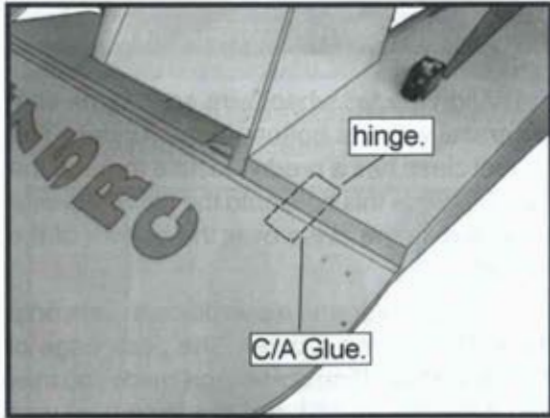

CONTROL HORN INSTALLATION.

Control horn installation as same as method of aileron wing. See pictures below.

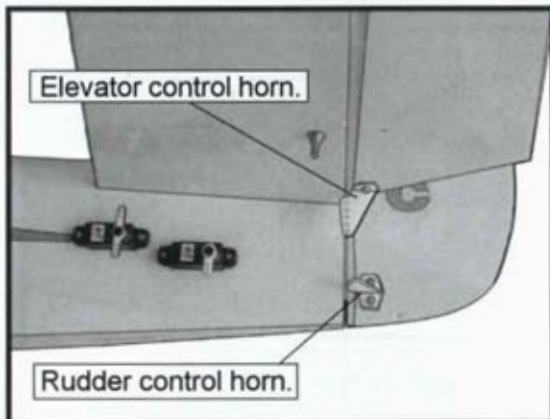
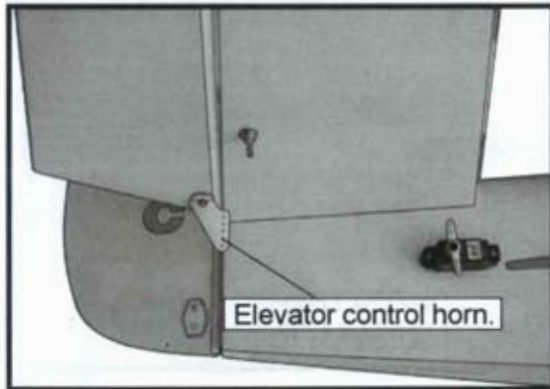

PUSHROD INSTALLATION.

Pushrod install as same as method of pushrod of aileron. See pictures below.

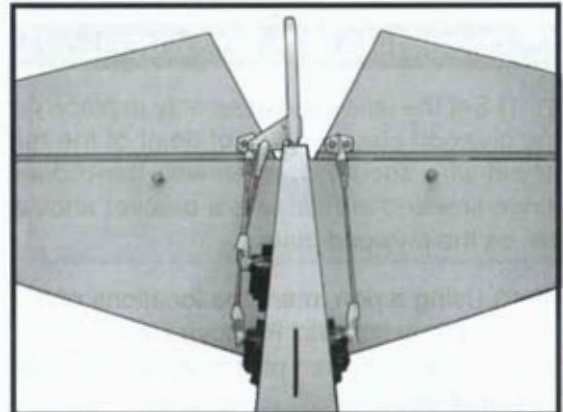
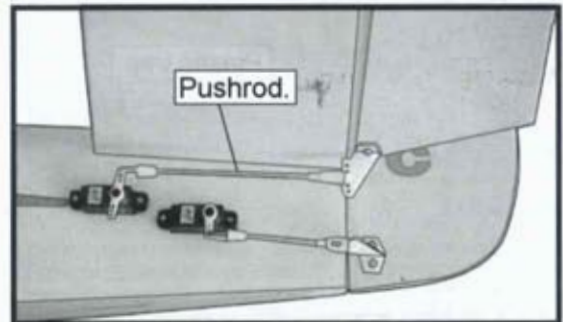
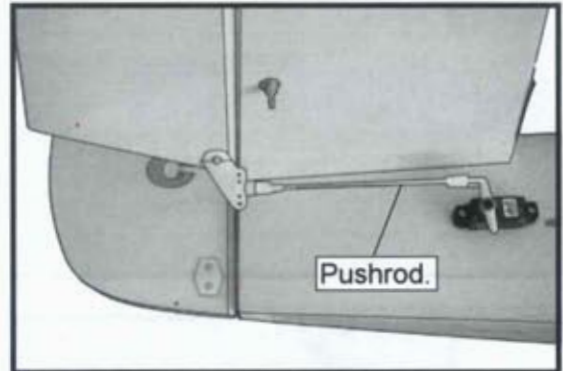

INSTALLING TAIL STRUT SYSTEM.

The tail strut system assembly follow pictures below.

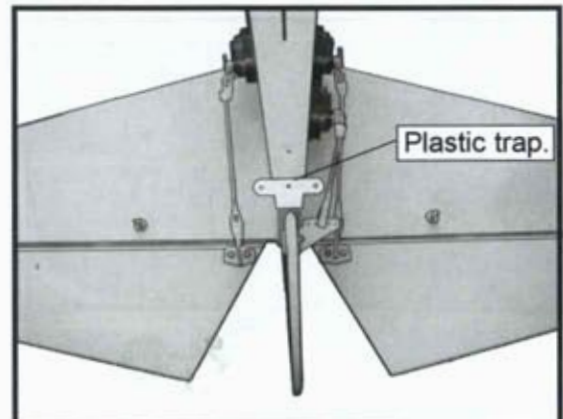

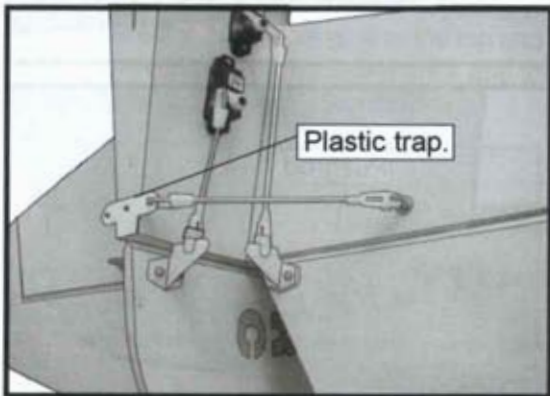
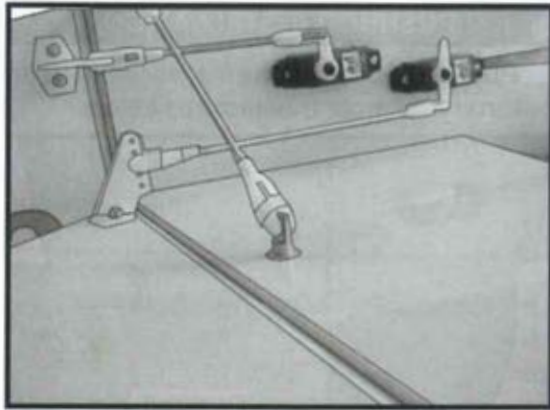

MOUNTING THE TAIL WHEEL.

- 1) Set the tail wheel assembly in place on the plywood plate. The pivot point of the tail wheel wire should be even with the rudder hinge line and the tail wheel bracket should be on the plywood plate.
- 2) Using a pen, mark the locations of the two mounting screws. Remove the tail wheel bracket and drill 1mm pilot holes at the locations marked.
- 3) Secure the tail wheel bracket in place using two 3x10mm wood screws. Be careful not to overtighten the screws.

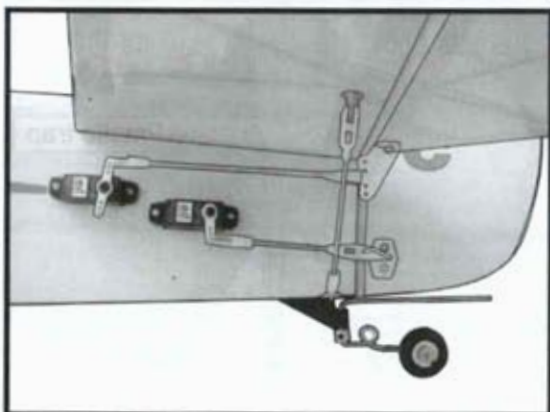

MOUNTING THE CONTROL CLASP.

1) Align the tail wheel wire so that the wire is parallel with the bottom of the rudder. The control clasp has a predrilled hole through the top of it. Slide this hole onto the tail wheel wire while sliding the clasp over the bottom of the rudder.

2) Using a ruler and a pen place a mark onto the bottom of the rudder. The back edge of the clasp should line up with this mark. You may find it necessary to bend the tail wheel wire down slightly so it lines up with the clasp without binding.

3) While holding the clasp firmly in place, use a pen and outline the clasp onto the rudder.

4) Remove the clasp, and using a modeling knife, remove the covering from inside the lines you drew. Use .220 grit sandpaper and carefully roughen the inside surface of the nylon clasp.

5) Slide the clasp back into position and carefully glue it into place using Kwik Bond Thin C/A. Hold the clasp in place until the glue completely cures. Secure by 1 machine screw.

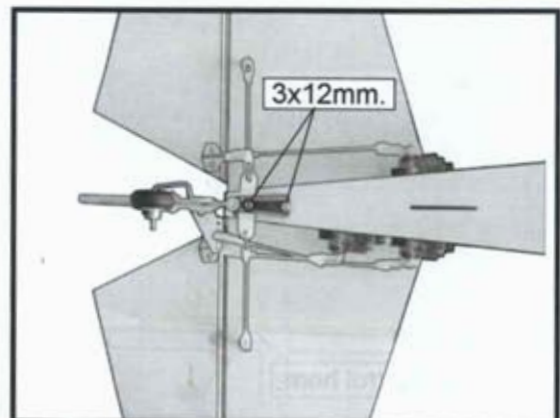
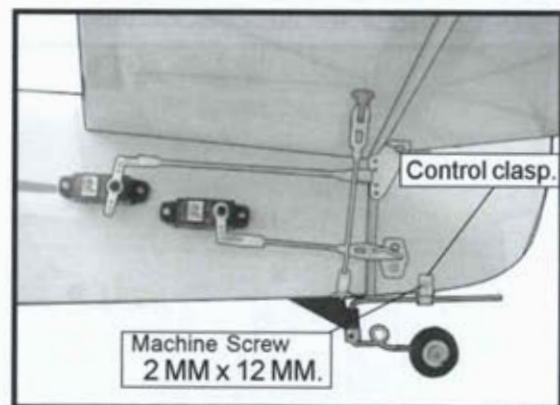

WHEEL AND WHEEL PANTS INSTALLATION.

□ 1) Assemble and mounting the wheel pants as shown in the following pictures.

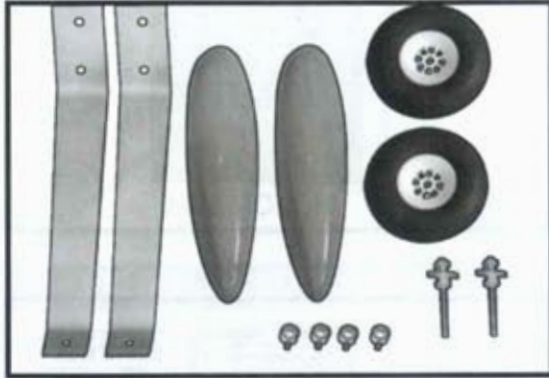

□ 2) Follow diagram below for wheel part installation:

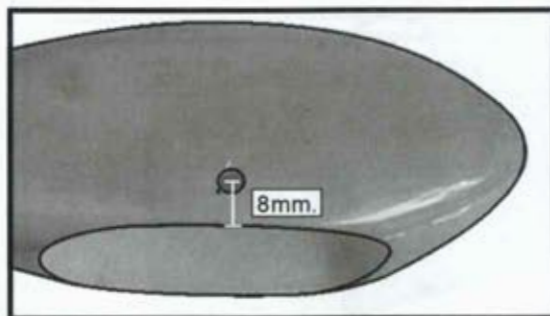
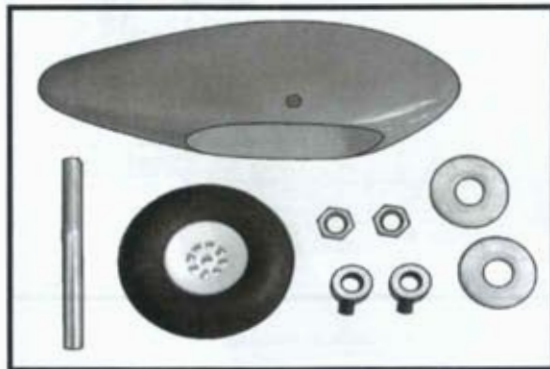
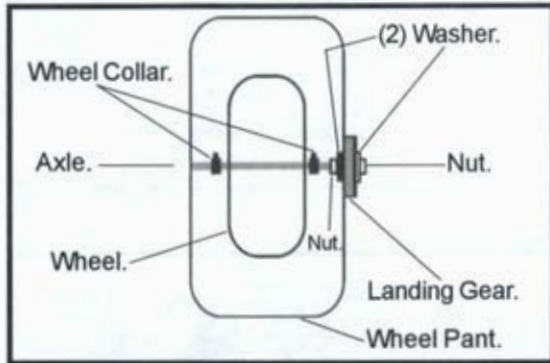

□ 3) You have to trim each axle using a tool cutting and cut-off wheel.

⚠ Caution when cutting the axles and wear protective goggles.

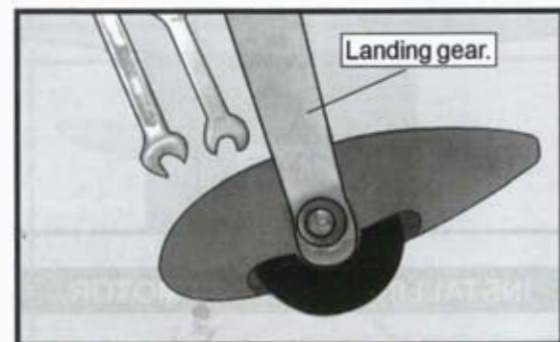
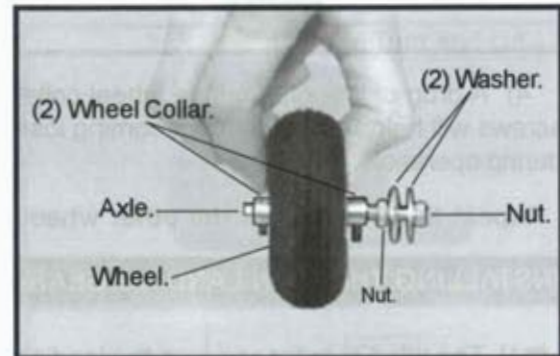
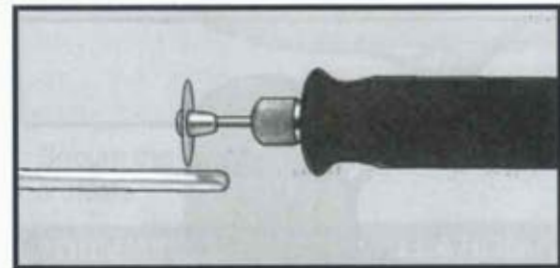
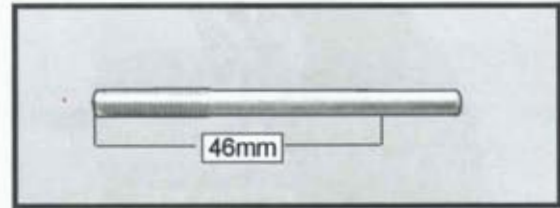

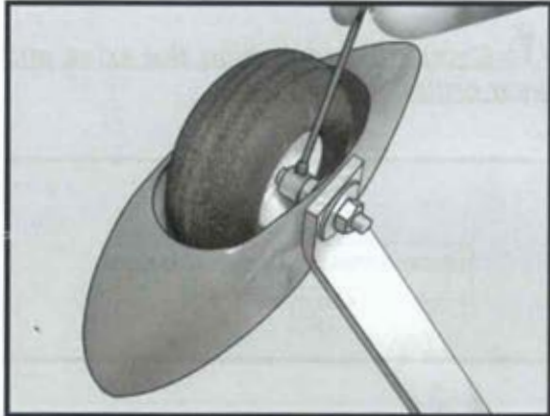

4) A drop of C/A glue on the wheel collar screws will help keep them from coming loose during operation.

Repeat the process for the other wheel.

INSTALLING THE MAIN LANDING GEAR.

- 1) The blind nuts for securing the landing gear are already mounted inside the fuselage.
- 2) Using the hardware provided, mount the main landing gear to the fuselage.

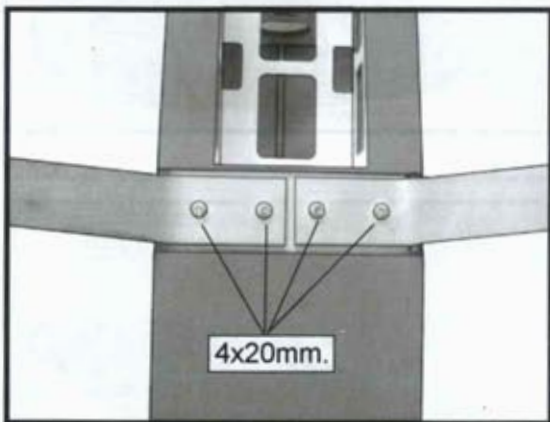

INSTALLING ELECTRIC MOTOR.

There are 2 mounting box for your option. It is depended your motor size.

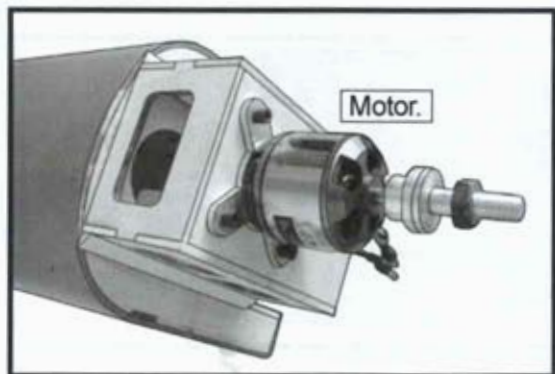
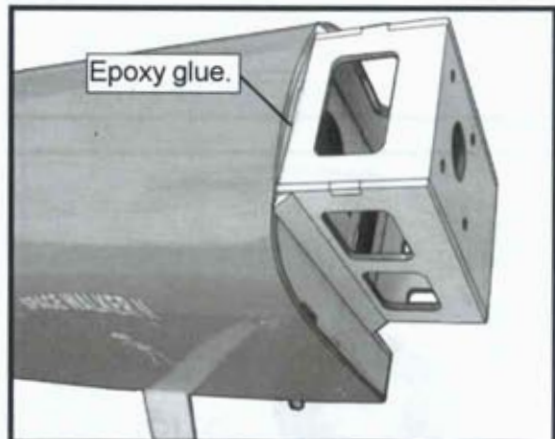
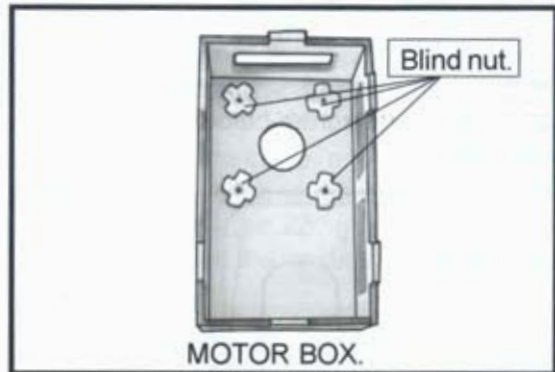
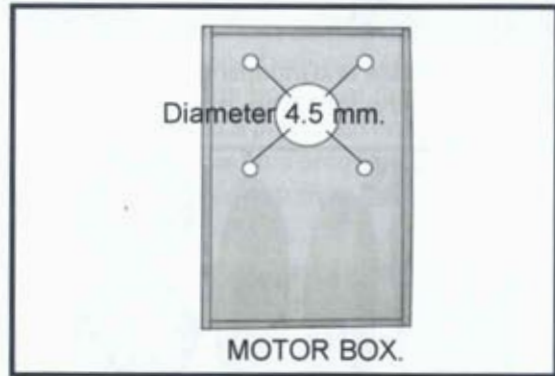

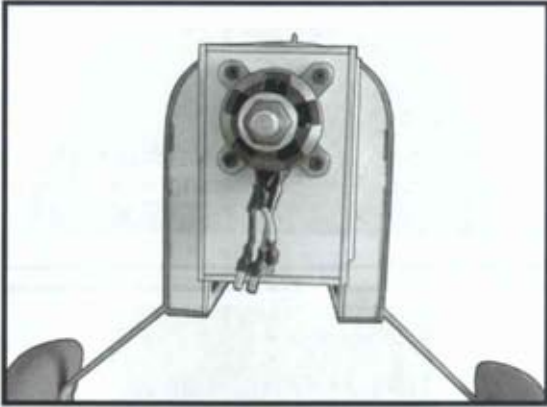

INSTALLING THE BATTERY.

See pictures below:

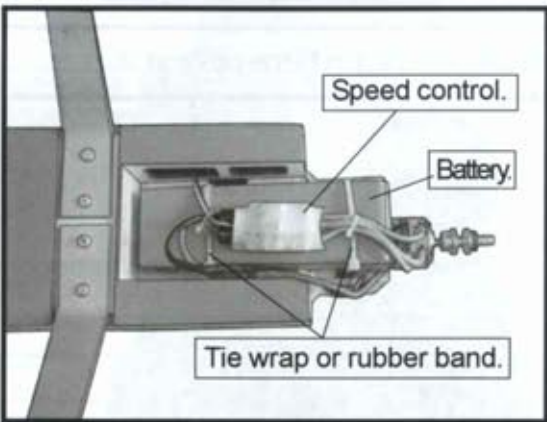

COWLING INSTALLATION.

See pictures below.

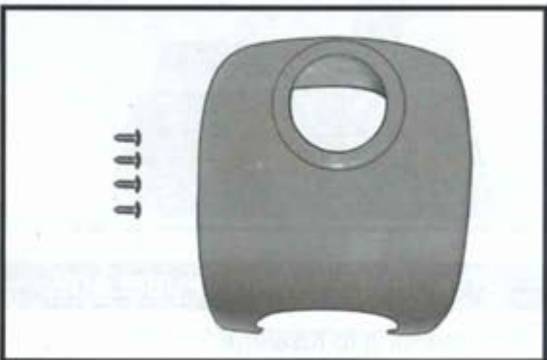

Slide the fiberglass cowl over the engine and line up the back edge of the cowl with the marks you made on the fuselage then trim and cut.

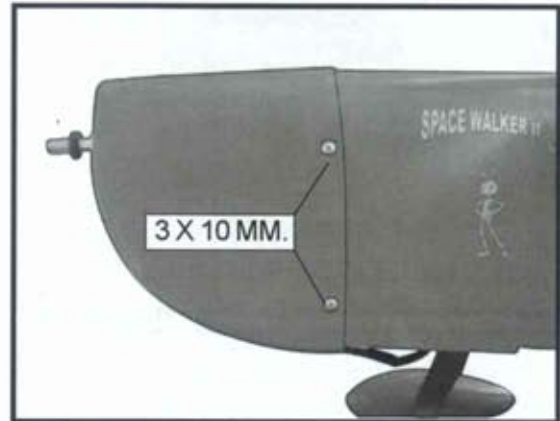

Secure the cowl with the screw provide with hardware.

DUMMY ENGINE INSTALLATION.

See pictures below.

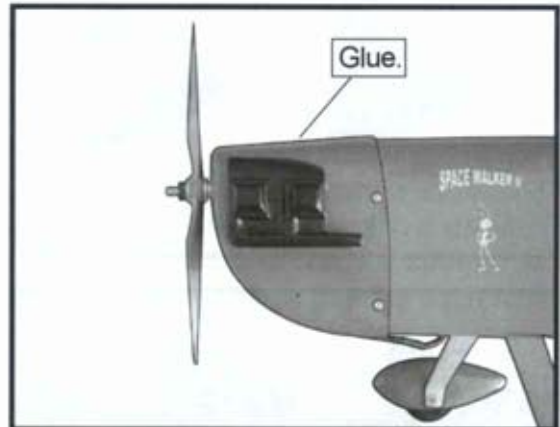

INSTALLING THE RECEIVER.

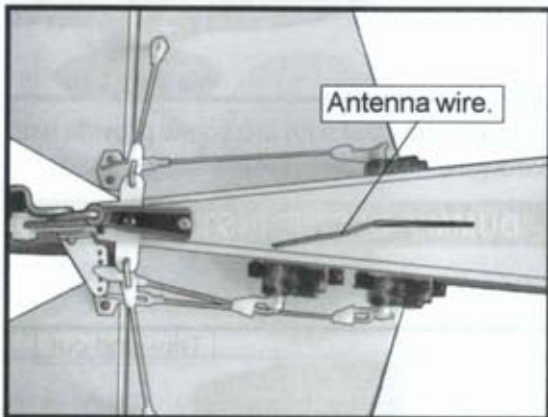
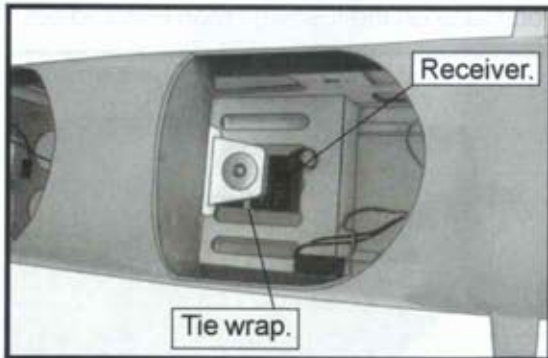

WIND SHIELD INSTALLTION.

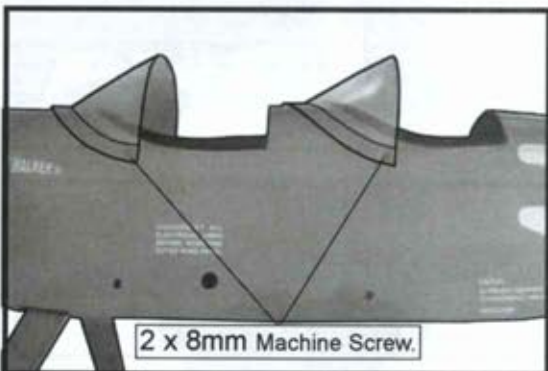
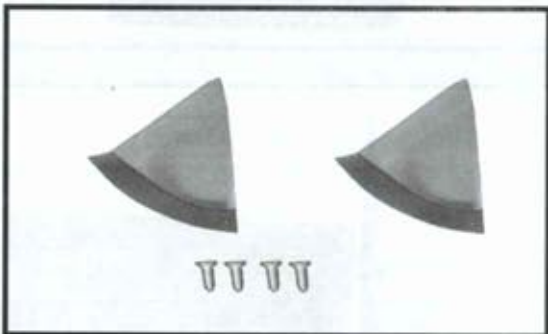

PILOT INSTALLATION.

1 Remove the fastening wire as same as picture below.

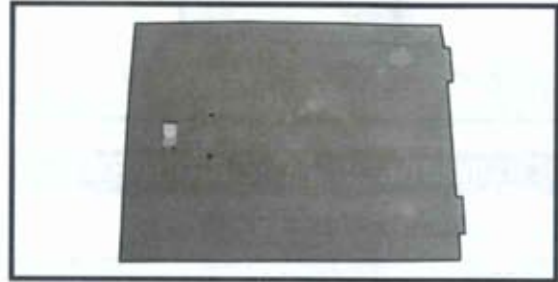
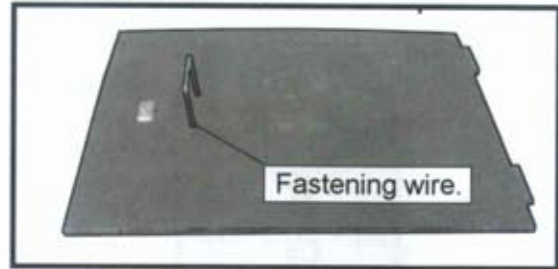

2 Glue the pilot in to the position.

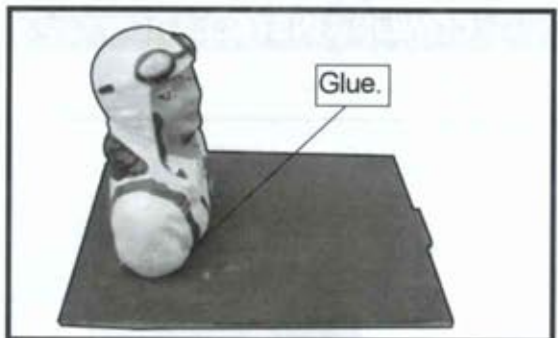
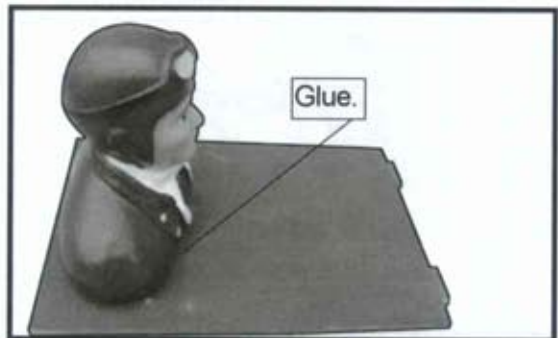

ATTACHMENT WING - FUSELAGE.

Bolt the wing to fuselage.

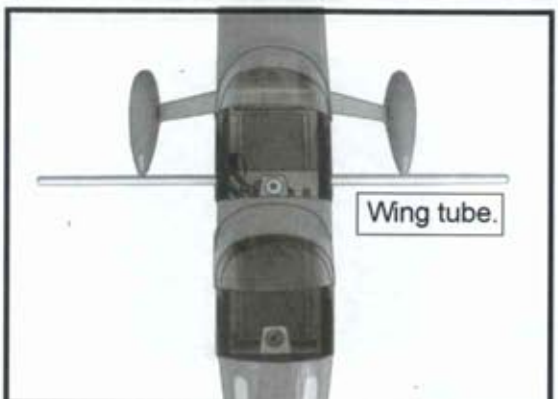

Insert two wing panels as pictures below.

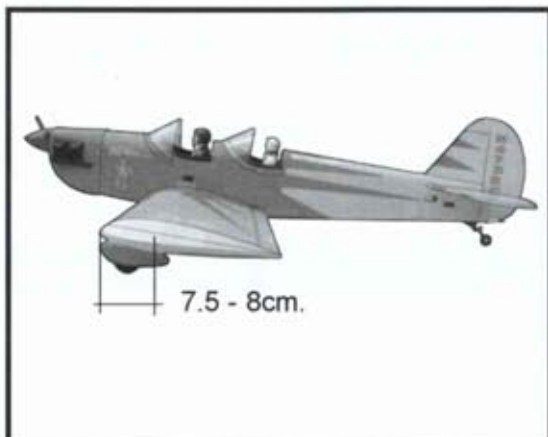
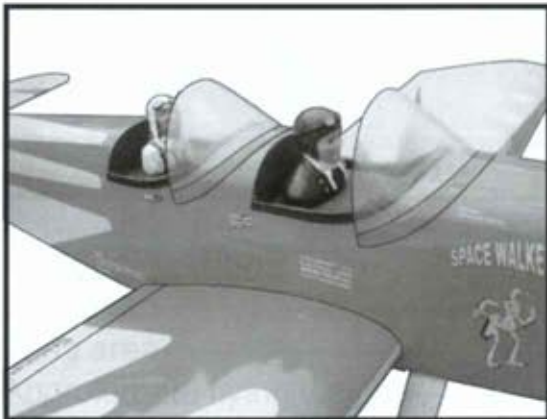
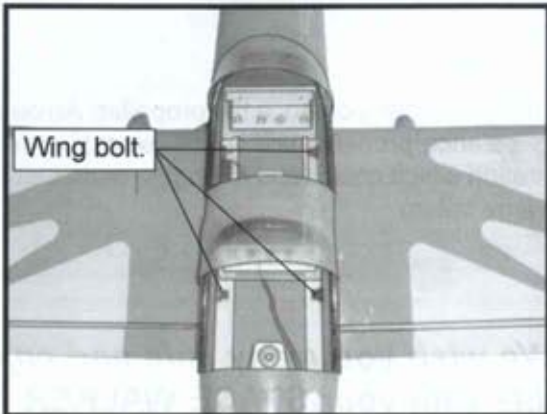
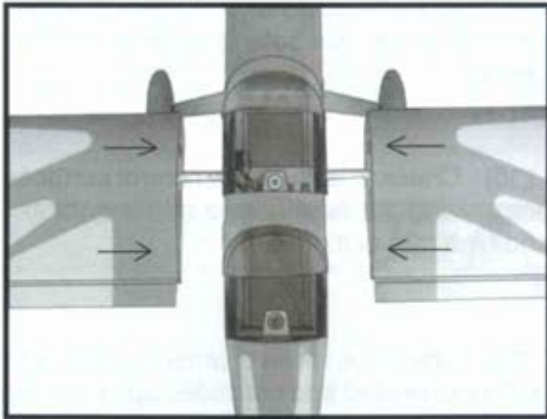

BALANCING.

□1) It is critical that your airplane be balanced correctly. Improper balance will cause your plane to lose control and crash. The center of gravity is located **7.5-8cm** back from the leading edge of the wing, measured at wing tip.

□2) If the nose of the plane falls, the plane is nose heavy. To correct this first move the battery pack further back in the fuselage. If this is not possible or does not correct it, stick small amounts of lead weight on the fuselage sides under the horizontal stabilizer. If the tail of the plane falls, the plane is tail heavy. To correct this, move the battery and receiver forward or if this is not possible, stick weight onto the firewall. When balanced correctly, the airplane should sit level or slightly nose down when you lift it up with your fingers.

CONTROL THROWS.

□1) We highly recommend setting up the **SPACE WALKER II** using the control throws listed at right. We have listed control throws for both Low Rate (initial test flying/sport flying) and High Rate (aerobatic flying).

□2) Turn on the radio system, and with the trim tabs on the transmitter in neutral, center the control surfaces by making adjustments to the clevises or adjustable servo connectors. The servo arms should be centered also.

□3) When the elevator, rudder and aileron control surfaces are centered, use a ruler and check the amount of the control throw in each surface. **The control throws should be measured at the widest point of each surface!**

INITIAL FLYING/SPORT FLYING

Ailerons :	3/16" up	3/16" down
Elevator :	3/8" up	3/8" down
Rudder :	1" right	1" left

AEROBATIC FLYING

Ailerons :	3/8" up	3/8" down
Elevator :	1" up	1" down
Rudder :	2" right	2" left

Do not use the aerobatic settings for initial test flying or sport flying.

4) By moving the position of the adjustable control horn out from the control surface, you will decrease the amount of throw of that control surface. Moving the adjustable control horn toward the control surface will increase the amount of throw.

FLIGHT PREPARATION.

A) Check the operation and direction of the elevator, rudder, ailerons and throttle.

B) Plug in your radio system per the manufacturer's instructions and turn everything on.

C) Check the elevator first. Pull back on the elevator stick. The elevator halves should move up. If it they do not, flip the servo reversing switch on your transmitter to change the direction.

D) Check the rudder. Looking from behind the airplane, move the rudder stick to the right. The rudder should move to the right. If it does not, flip the servo reversing switch on your transmitter to change the direction.

E) Check the throttle. Moving the throttle stick forward should open the carburetor barrel. If it does not, flip the servo reversing switch on your transmitter to change the direction.

F) From behind the airplane, look at the aileron on the right wing half. Move the aileron stick to the right. The right aileron should move up and the other aileron should move down. If it does not, flip the servo reversing switch on your transmitter to change the direction.

PREFLIGHT CHECK.

1) Completely charge your transmitter and receiver batteries before your first day of flying.

2) Check every bolt and every glue joint in the **SPACE WALKER II** to ensure that everything is tight and well bonded.

3) Double check the balance of the airplane. Do this with the fuel tank empty.

4) Check the control surfaces. All should move in the correct direction and not bind in any way.

5) If your radio transmitter is equipped with dual rate switches double check that they are on the low rate setting for your first few flights.

6) Check to ensure the control surfaces are moving the proper amount for both low and high rate settings.

7) Check the receiver antenna. It should be fully extended and not coiled up inside the fuselage.

8) Properly balance the propeller. An out of balance propeller will cause excessive vibration which could lead to engine and/or airframe failure.

We wish you many safe and enjoyable flights with your SPACE WALKER II.