



# Jumper 25

HIGH WING TRAINER - ENGINE SIZE .25 - 2STROKE

Hand-made Almost Ready to Fly R/C Model Aircraft

## ASSEMBLY MANUAL

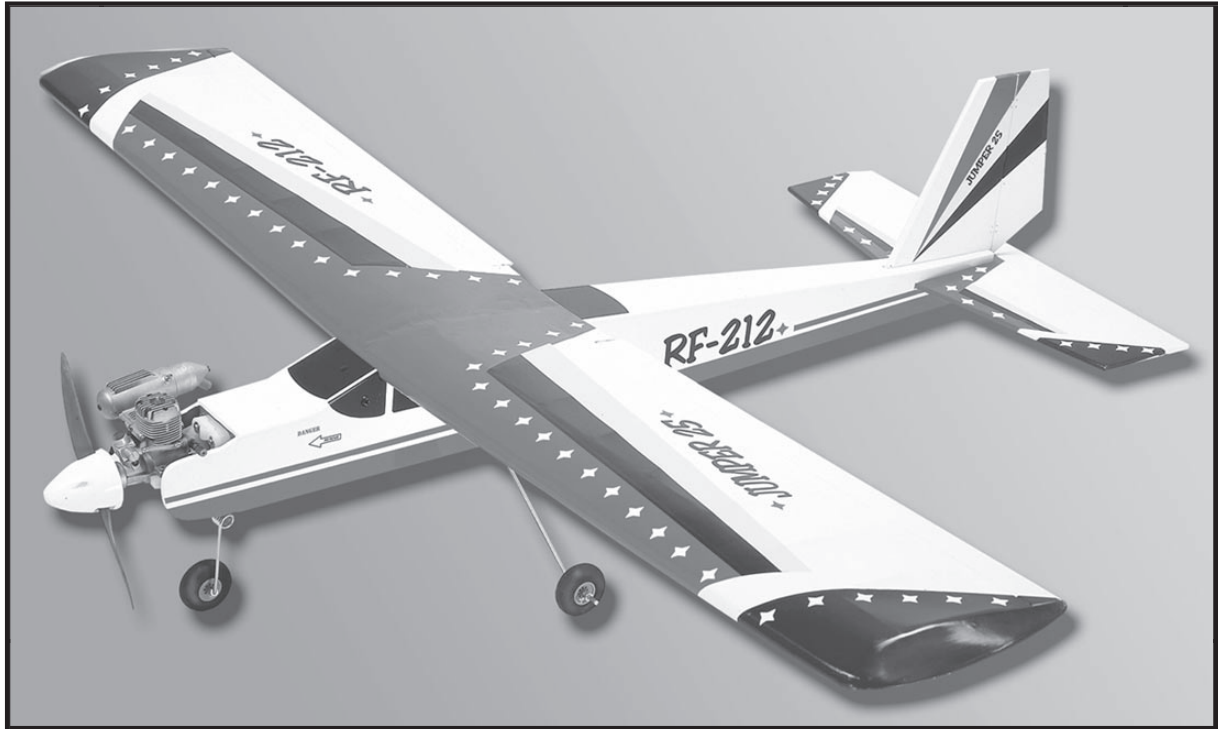

## FACTORY BUILT MODEL

### Specifications

Wingspan \_\_\_\_\_ , 157cm  
Wing area \_\_\_\_\_ 1256Cm<sup>2</sup>  
Approximate flying weight \_\_\_\_\_ , 2.5kg  
Recommended engine size \_\_\_ 0.25-0.32 cu. ins 2-stroke  
Recommended R/C \_\_\_\_\_ 4 channel minimum  
Flying skill level \_\_\_\_\_ High wing Trainer

### Additional items required

Engine  
4 Channel or greater Radio Control system  
Glues  
Tools  
Starting Equipment

### Kit features

- Ready-made—minimal assembly & finishing required
- Ready-covered—including decals, trim & covering
- **Factory-installed pushrod**
- Factory-installed metal engine mount
- Factory-pinned & glued control surface hinges for ultimate safety
- Comprehensive hardware pack including wheels, tank, spats, undercarriage & spinner
- Photo-illustrated step-by-step Assembly Manual

Distributed throughout Europe by:  
J Perkins Distribution Ltd, Kent, UK.  
<http://www.jperkinsdistribution.co.uk>

Made in Vietnam

**FACTORY BUILT MODEL**



Thank you for choosing the **Jumper 25** ARTF by SEAGULL MODELS. The **Jumper 25** was designed with the intermediate/advanced sport flyer in mind. It is a High-wing aeroplane which is easy to fly and quick to assemble. The airframe is conventionally built using balsa, plywood and veneer to make it stronger than the average ARTF, yet the design allows the aeroplane to be kept light. You will find that most of the work has been done for you already. The pushrods are pre-made to the correct lengths, the motor mount has been fitted and the hinges are pre-installed and pinned for security. Flying the **Jumper 25** is simply a joy.

This instruction manual is designed to help you build a great flying aeroplane. Please read this manual thoroughly before starting assembly of your **Jumper 25**. Use the parts listing below to identify all parts.

We encourage you to let us know your comments. Fill out the consumer feedback survey at the back of this manual, send us a letter or contact us at [jpmail@jpmodels.co.uk](mailto:jpmail@jpmodels.co.uk) or [Modeng@iaccess.com.au](mailto:Modeng@iaccess.com.au) (Australia) or [Phat.cgm@hcm.vnn.vn](mailto:Phat.cgm@hcm.vnn.vn) (Vietnam).

## Warning

Please be aware that this aeroplane is not a toy and if assembled or used incorrectly it is capable of causing injury to people or property. **WHEN YOU FLY THIS AEROPLANE YOU ASSUME ALL RISK & RESPONSIBILITY.**

If you are inexperienced with basic R/C flight we strongly recommend you contact your R/C supplier and join your local R/C Model Flying Club. R/C Model Flying Clubs offer a variety of training procedures designed to help the new pilot on his way to successful R/C flight. They will also be able to advise on any insurance and safety regulations that may apply.

- ▼ 25-32 2-stroke engine
- ▼ 4-channel radio with four servos
- ▼ Glow plug to suit engine
- ▼ Propeller to suit engine
- ▼ Protective foam rubber for radio system
- ▼ Silicone fuel line
- ▼ Stick-on weights for balance (If necessary)
- ▼ Thick cyanoacrylate glue
- ▼ 30 minute epoxy
- ▼ 5 minute epoxy
- ▼ Hand or electric drill
- ▼ Assorted drill bits
- ▼ Modelling knife
- ▼ Straight edge ruler
- ▼ 2mm ball driver
- ▼ Phillips head screwdriver
- ▼ 220 grit sandpaper
- ▼ 90° square or builder's triangle
- ▼ Wire cutters
- ▼ Masking tape & T-pins
- ▼ Thread-lock
- ▼ Paper towels

## FUSELAGE ASSEMBLY

- ▼ (1) Fuselage
- ▼ (1) Pre-installed throttle pushrod & tube
- ▼ (1) Pre-installed servo tray
- ▼ (1) Pre-installed motor mount
- ▼ (1) Pre-installed rudder pushrod
- ▼ (1) Pre-installed elevator pushrod

## WING ASSEMBLY

- ▼ (1) Right wing half with pre-installed aileron
- ▼ (1) Left wing half with pre-installed aileron
- ▼ (1) Plywood wing dihedral brace
- ▼ (1) Covering strip for centre section joint

## TAIL SECTION ASSEMBLY

- ▼ (1) Vertical stabilizer with pre-installed rudder
- ▼ (1) Horizontal stabilizer with pre-installed elevator halves

## HARDWARE PACK

- (1) Moulded plastic fuel tank
- (1) Pre-assembled fuel tank stopper
- (1) Weighted fuel pick-up (clunk)
- (2) Main wheels
- (1) Undercarriage
- (2) 3 x 12mm metal screws for spinner
- (4) 3 x 250mm metal screws for main u/c
- (1) Spinner with backplate
- (4) Wheel collars with four 3 x 18mm set screws
- (2) 140mm long threaded rod for aileron pushrods
- (5) Nylon clevises
- (1) Adjustable servo connector
- (5) Nylon snap keepers
- (5) 3 x 350mm machine screws, washers & nuts
- (5) Nylon adjustable control horns
- (2) Nylon wing bolts
- (4) 4 x 30mm machine screws
- (8) 4mm washers
- (4) 4mm nuts

**NOTE:** To avoid scratching your new aeroplane we suggest that you cover your workbench with an old towel. Keep a couple of jars or bowls handy to hold the small parts after you open the bags.

Please trial fit all parts. Make sure you have the correct parts and that they fit and are aligned properly before gluing! This will ensure proper assembly as the **Jumper 25** is made from natural materials and minor adjustments may have to be made.

The paint and plastic parts used in this kit are fuel proof. However, they are not tolerant of many harsh chemicals including the following: paint thinner, cyano-acrylate glue accelerator, cyanoacrylate glue de-bonder and acetone. Do not let these chemicals come in contact with the colours on the covering and the plastic

**NOTE:** We highly recommend using 30 minute epoxy as it is stronger and provides more working time, allowing the builder to properly align the parts. Using fast cure epoxy when joining the wing halves could

result in the glue drying before the wing halves are aligned properly which may result in failure of the wing centre section during flight.

- ▼ 1. Locate the plywood wing dihedral brace. Using a ruler, locate its centre and draw a vertical line .

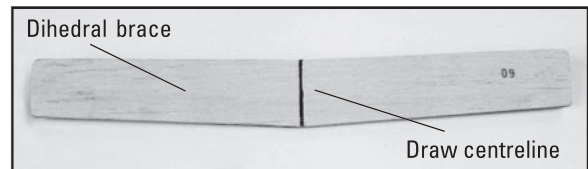

- ▼ 2. Test fit the dihedral brace into each wing half. The brace should slide in easily up to the centreline that you drew. If not, use 220 grit sandpaper with a sanding block and sand down the edges and ends of the brace until it fits properly.

**NOTE:** The dihedral brace is cut in the shape of a "V". This shape gives the wing the correct dihedral angle. Make sure you do not test fit the brace upside down.

- ▼ 3. Remove the brace when satisfied with its fit in each wing half. Coat both sides of one half of the dihedral brace with 30 minute epoxy. Next, pour some epoxy into the dihedral box in one wing panel. Make sure you cover the top and bottom as well as the sides of the dihedral brace. Use enough epoxy to fill any gaps.

- ▼ 4. Insert the dihedral brace into the dihedral box up to the centreline. With paper towels wipe off any excess epoxy that may have squeezed out of the joint .

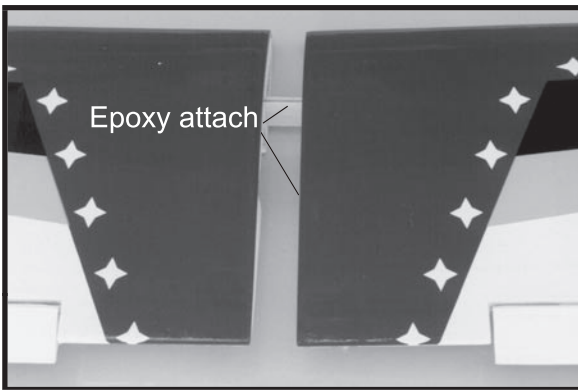
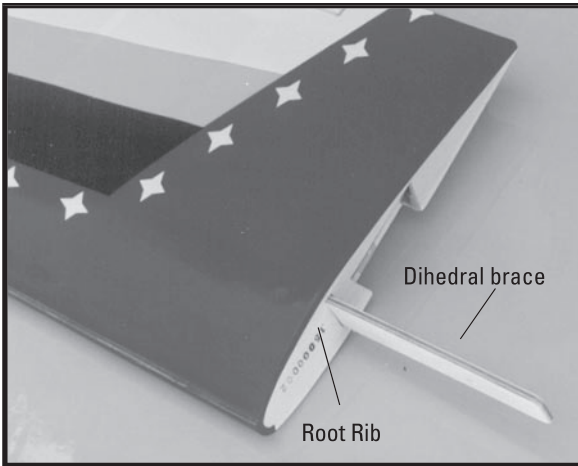

- ▼ 5. Once the epoxy has cured, trial fit both wing halves together. The centre ribs should fit together flush with no gaps. If gaps do exist, use 220 grit sandpaper and sand down the high spots on the root ribs and the wing joiner until a proper fit is achieved. The correct amount of dihedral is ready-built into the wings. With one wing half laid flat on the table, the other wing tip should be approximately 8cm off the table surface. If this needs to be adjusted, you may do so by sanding small amounts from the centre ribs or dihedral brace.
- ▼ 6. Carefully apply masking tape around the top and bottom edge of the root rib of each wing half to protect them from damage caused by epoxy.
- ▼ 7. Mix a generous amount of 30 minute epoxy. Coat the exposed half of the dihedral brace, and the remaining wing joiner box and both root ribs with epoxy. Slide the two wing halves together and carefully align them at the leading and trailing edges. Wipe away any excess epoxy using paper towels. Use masking tape wrapped around the centre section to hold the halves in place until the epoxy cures.
- ▼ 8. When the epoxy has cured, carefully remove the masking tape from the wing.
- ▼ 9. Peel off the backing from the self adhesive covering strip. Apply the strip to the centre section of the wing starting from the bottom trailing edge. Wrap the strip all the way around the wing until it meets the trailing edge again. Trim off any excess strip.

## SERVO INSTALLATION

### PARTS REQUIRED

- ▼ {1} Plywood Aileron Servo Mount

### INSTALLING THE AILERON SERVO MOUNT

- ▼ 1) Install the rubber grommets and brass collets onto the aileron servo. Test fit the servo into the aileron servo mount.

 Because the size of servos differ, you may need to adjust the size of the pre-cut opening in the mount. The notch in the sides of the mount allow the servo lead to pass through.

- ▼ 2) Remove the aileron servo. Place the mount onto the wing, aligning the cutout in the mount with the cutout in the wing. The two notches in the mount should face the leading edge of the wing.

- ▼ 3) While holding the servo mount firmly in place, trace around it using a pen.

- ▼ 4) Remove the mount, and using a modeling knife, carefully remove the covering from inside the outline you drew.

- ▼ 5) Using Kwik Bond 5 Minute Epoxy, glue the servo mount into place. Remove any excess epoxy using a paper towel and rubbing alcohol. Use pieces of masking tape to hold the tray in place until the epoxy fully cures.

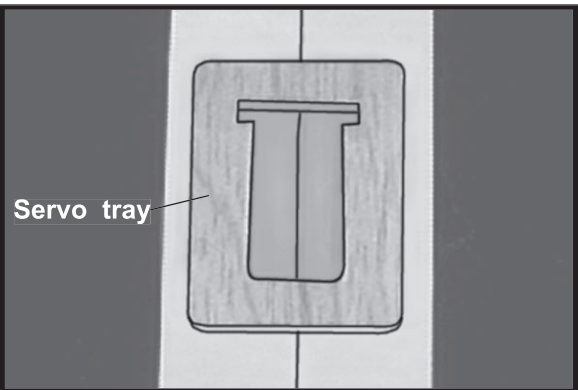

## INSTALLING THE AILERON SERVO

▼ 6) Install the aileron servo into the servo mount, with the output shaft towards the leading edge of the wing, using the wood screws provided with your radio system. Drill 1/16" pilot holes through the mount

before installing the screws. This will prevent the wood from splitting.

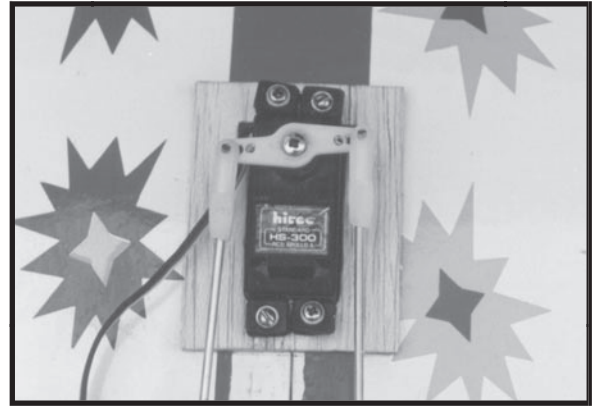
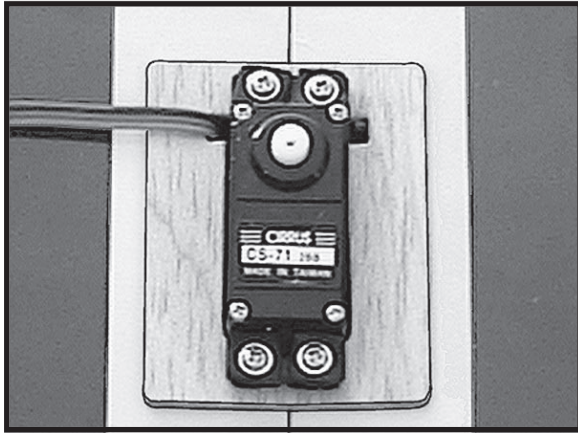

▼ 5) Slide the pushrod wires following picture bellow.

▼ 6) With both the aileron servo and the ailerons centered.

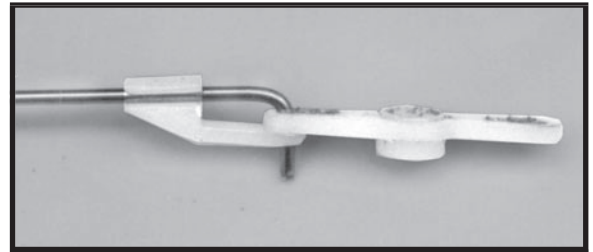

## AILERON LINKAGE

### PARTS REQUIRED

- {2} 2mm x 170mm Threaded Wires
- {2} Nylon Adjustable Control Horns
- {2} Nylon Clevises
- {2} Adjustable Servo Connector Assemblies

## INSTALLING THE AILERON LINKAGE

▼ 1) Thread one nylon adjustable control horn onto each aileron torque rod. Thread the horns on until they are flush with the ends of the torque rods.

▼ 2) Thread one nylon clevis at least 5/16" onto each of the two 2mm x 170mm threaded wires.

▼ 3) With the aileron servo centered, install the servo arm onto the servo. The arm should be installed so it is parallel with the trailing edge of the wing.

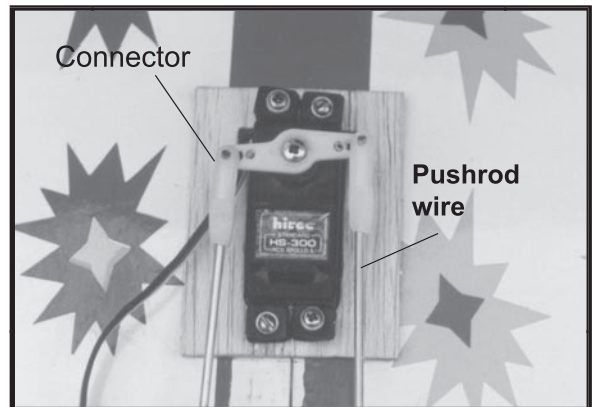

## LANDING GEAR INSTALLATION

### PARTS REQUIRED

- {2} Prebent Main Gear Wires
- {2} 60mm Diameter Wheels
- {4} Nylon Landing Gear Straps
- {8} 3mm x 12mm Wood Screws
- {4} Wheel Collars w/3mm x 6mm Set Screws

### INSTALLING THE MAIN GEAR WIRES

▼ 1) Using a modeling knife, remove the covering from over the two main gear mounting slots located in the bottom of the fuselage.

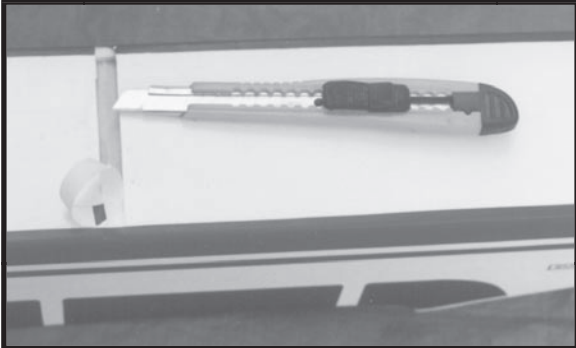

▼ 4) Using the two landing gear straps as a guide, mark the locations of the four 3mm x 12mm mounting screws onto the fuselage surface.

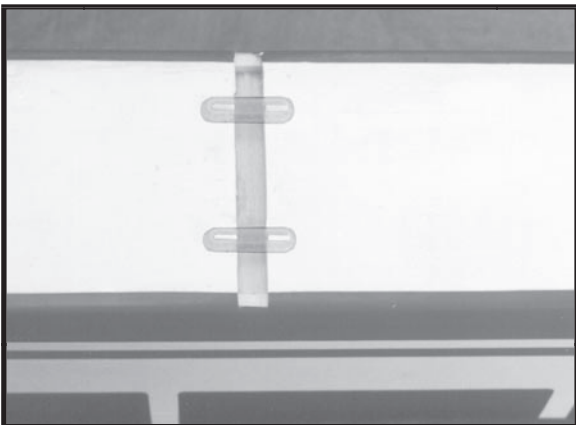

▼ 3) The landing gear wire is held in place using two nylon landing gear straps and four 3mm x 12mm wood screws.

The straps should be located equal distance from the inside and outside ends of the wire.

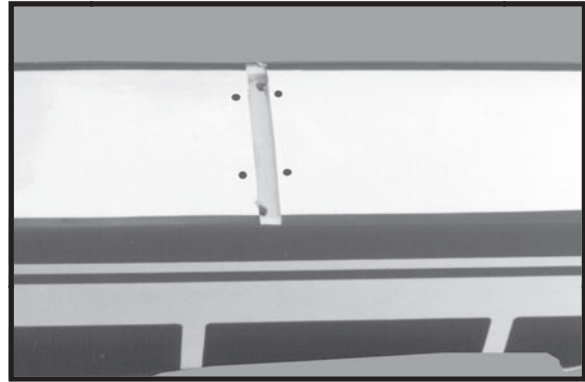

▼ 2) Insert the 90° bend of one main gear wire into the predrilled hole in one mounting slot.

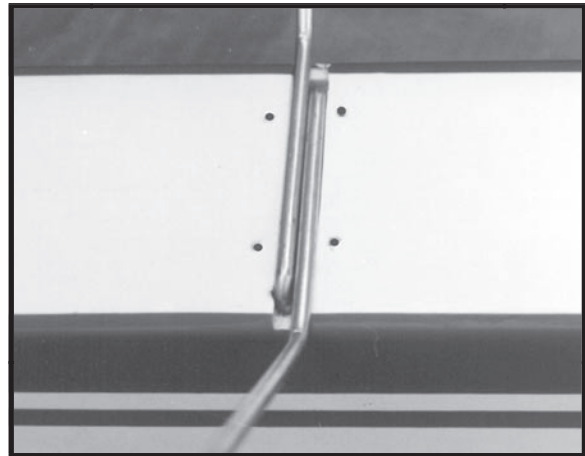

▼ 5) Remove the two straps and the gear wire. Drill four 3/32" pilot holes into the wing for the wood screws.

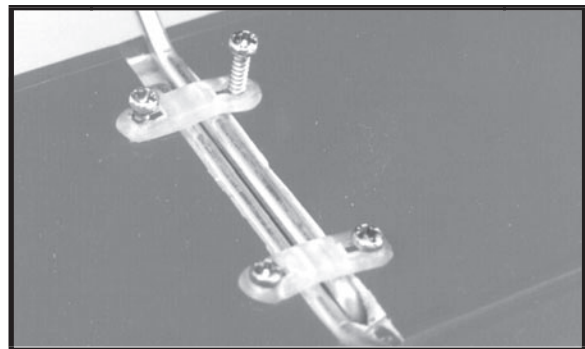

### INSTALLING THE MAIN GEAR WHEELS

▼ 8) Slide one wheel collar with 3mm x 6mm set screw onto each axle. Push the wheel collars on as far as they will go and tighten the set screws.

⚠ Be careful not to overtighten the set screws. Overtightening may cause the threads to strip.

▼ 9) Slide one 60mm diameter wheel onto each axle and push them up against the wheel collars. Slide the remaining wheel collars with 3mm x 6mm set screws onto the axles. Push them up against the wheels and tighten the set screws. The wheels should spin free and not bind in any way. If they do bind, loosen the set screws in the outer wheel collars and move the collars out a small amount. Retighten the set screws.



## NOSE GEAR INSTALLATION

### PARTS REQUIRED

- {1} Nose gear.
- {1} Steering arm.
- {1} Connector.
- {1} Wheel.

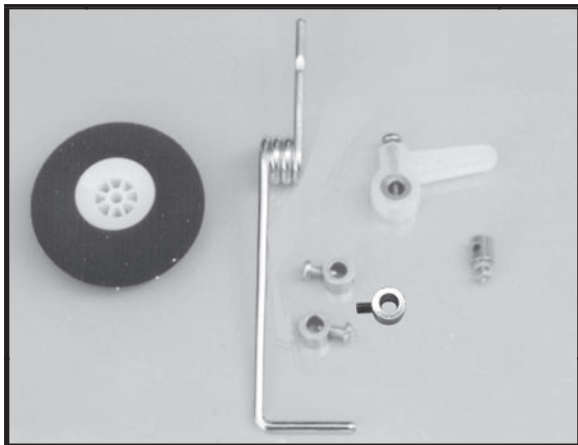

### TOOLS REQUIRED

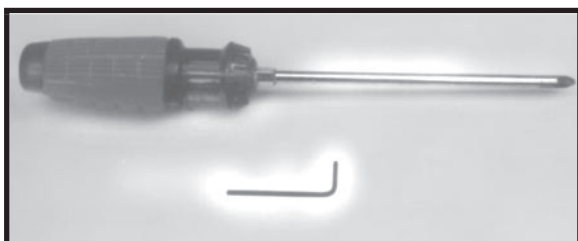

Installing steering arm as follow.

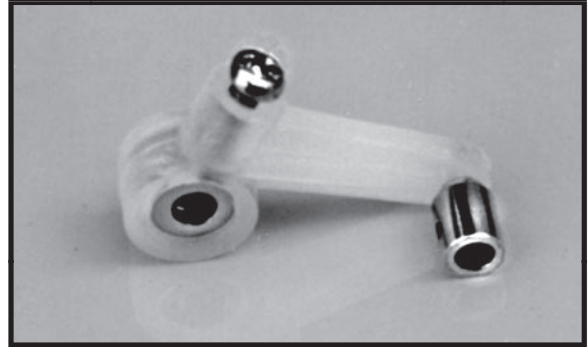

Adjust the nose gear steering arm until the arm is parallel with the fire wall.

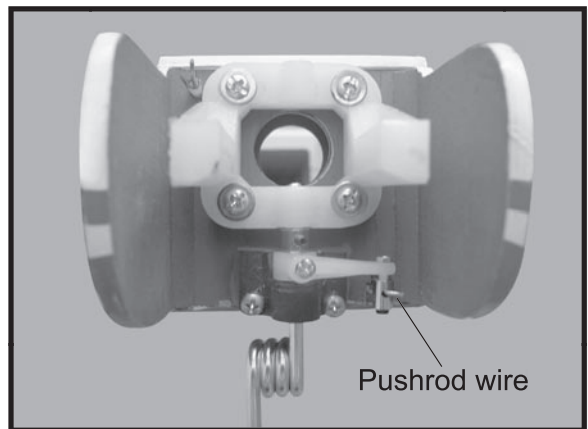

## INSTALLING THE MAIN GEAR WHEELS

Slide one 60mm diameter wheel onto each axle and push them up against the wheel collars. Slide the remaining wheel collars with 3mm x 6mm set screws onto the axles. Push them up against the wheels and tighten the set screws. The wheels should spin free and not bind in any way. If they do bind, loosen the set screws in the outer wheel collars and move the collars out a small amount. Retighten the set screws.



## FUEL TANK

### PARTS REQUIRED

- ▼ {1} Molded Nylon Fuel Tank
- ▼ {1} Preassembled Stopper Assembly
- ▼ {1} Metal Weighted Pick-Up
- ▼ {1} Molded Foam Fuel Tank Support
- ▼ {1} dowell

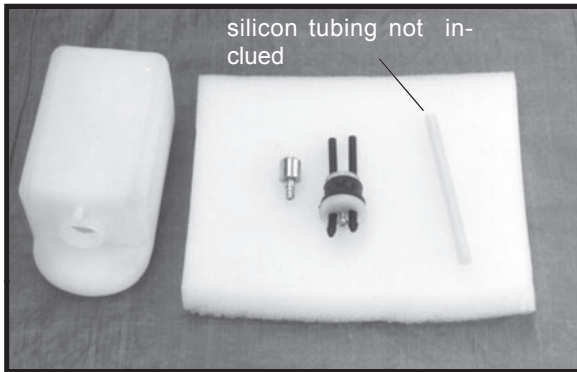

### INSTALLING THE STOPPER ASSEMBLY

▼ 1) Using a modeling knife, carefully cut off the rear portion of **one** of the two nylon tubes leaving 1/2" protruding from the rear of the stopper. This will be the fuel pick up tube.

▼ 2) Using a modeling knife, cut one length of silicon fuel line (not included) to 2-1/4" long. Connect one end of the line to the weighted fuel pickup and the other end to the nylon pickup tube.

▼ 3) Carefully bend the second nylon tube up at a 45° angle. This tube is the vent

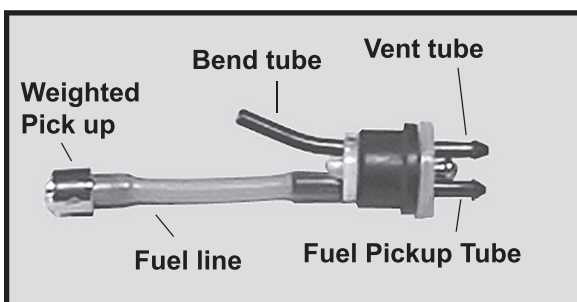

When the stopper assembly is installed in the tank, the top of the vent tube should rest just below the top surface of the tank. It should not touch the top of the tank.

▼ 4) Test fit the stopper assembly into the tank. It may be necessary to remove some of the flashing around the tank opening using a modeling knife. If flashing is present, make sure none falls into the tank.

▼ 5) With the stopper assembly in place, the weighted pickup should rest about 3/8" away from the rear of the tank and move freely inside the tank. The top of the vent tube should rest just below the top of the tank. It should not touch the top of the tank.

▼ 6) When satisfied with the alignment of the stopper assembly tighten the 3mm x 20mm machine screw until the rubber stopper expands and seals the tank opening. Do not overtighten the assembly as this could cause the tank to split.

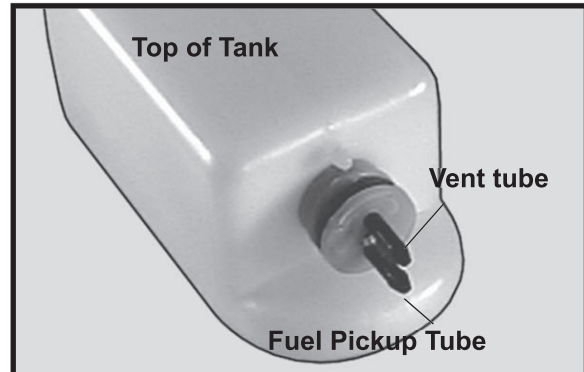



## INSTALLING THE FUEL TANK

### TOOLS REQUIRED

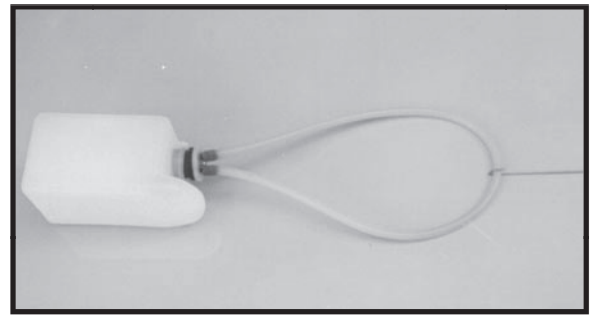
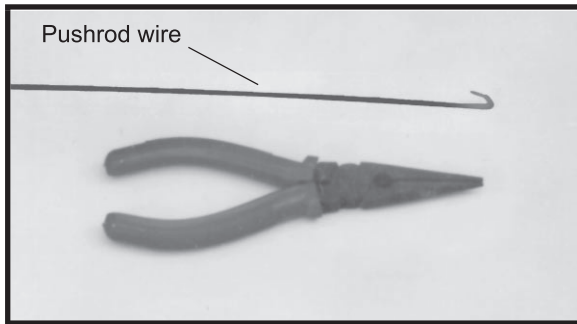

 Blow through one of the lines to ensure the fuel lines have not become kinked inside the fuel tank compartment. Air should flow through easily.

▼ 1) Using a modeling knife, cut one lengths of fuel line 20" long. Connect one line to the vent tube and one line to the fuel pick up tube on the stopper. See picture bellow.

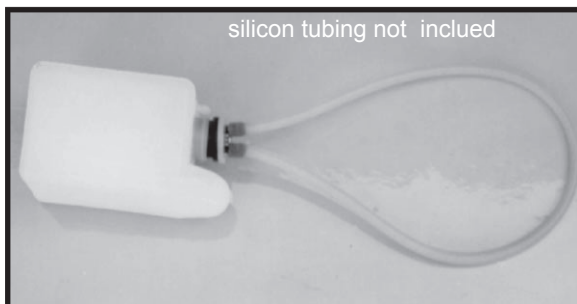
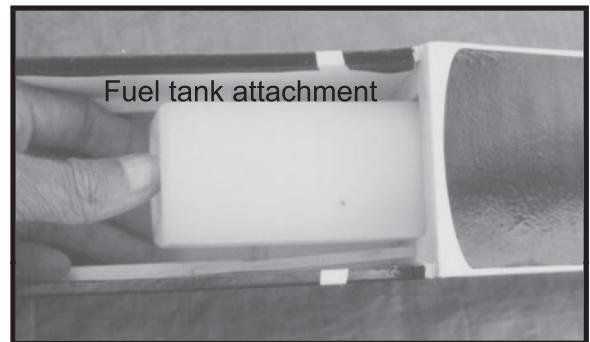

▼ 2) Feed both lines through the fuel tank compartment and through the predrilled hole in the firewall. Pull the lines out from behind the engine, while guiding the fuel tank into place. Push the fuel tank until the front of the tank touches the firewall.

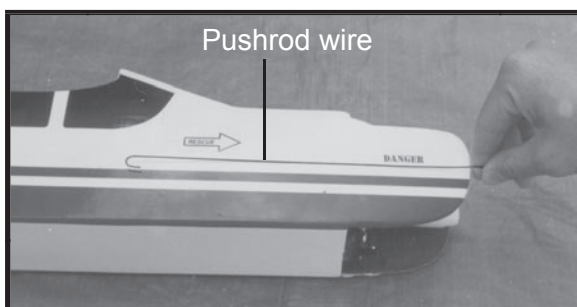
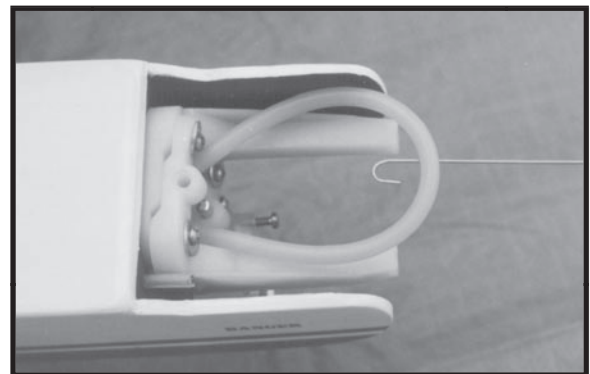

## MOUNTING THE ENGINE

### PARTS REQUIRED



▼ 1) Locate the second 500mm plain wire pushrod and second 400mm nylon pushrod housing. Install the pushrod housing through the predrilled hole in the firewall and into the servo compartment. The pushrod housing should protrude 1/4" out past the front of the firewall. Make a Z-Bend 1/4" from one end of the plain wire pushrod.

▼ 2) Screw 4 pilot horns 2.5 mm diameter on engine mount as follow.

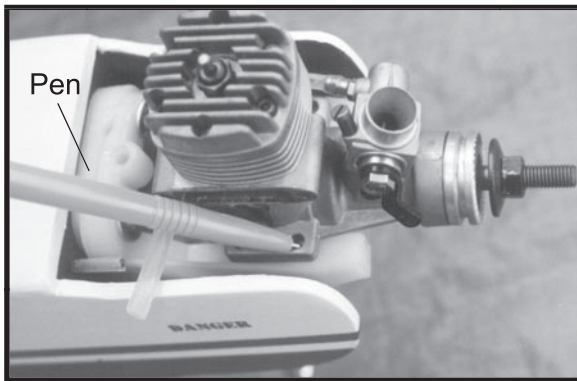

▼ 3) Temporarily bolt the plates to the motor mount, but do not completely tighten them down at this time. Leave them slightly loose so they can be moved if needed.

▼ 9) Attach the Z-Bend in the pushrod wire to the throttle arm on the carburetor. You will need to remove the throttle arm from the carburetor to be able to attach the Z-bend. When complete, reattach the throttle arm to the carburetor.

▼ 10) Locate the fuel tank assembly you built earlier. Connect two lengths of fuel line (not included) to the tubes coming out of the tank. Keep track which one is for the fuel pick-up and which one is for the muffler pressure.

▼ 11) Run the tubes through the hole in the firewall and slide the tank assembly into place. The stopper of the tank should rest in the predrilled hole in the firewall.

▼ 12) Use pieces of foam rubber to hold the tank in place. Be careful the tank or the foam doesn't interfere with the pushrods.

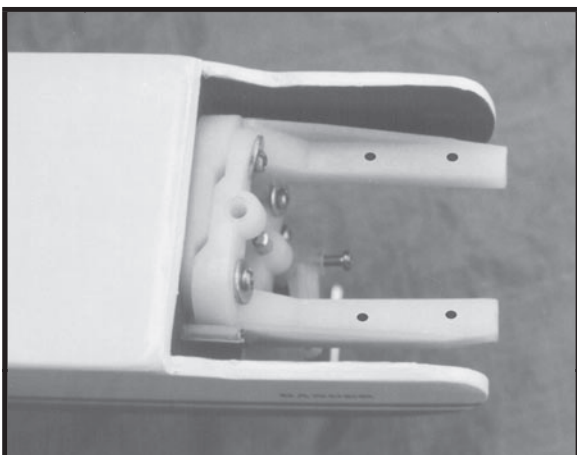
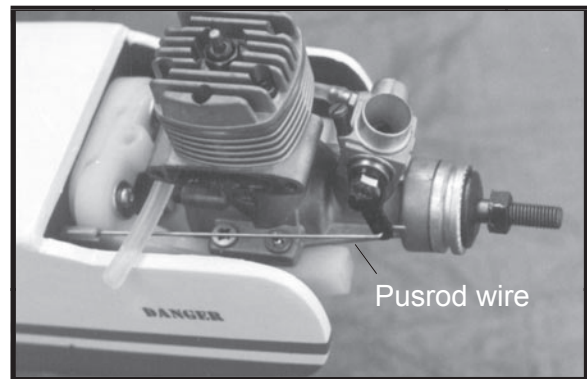

## PARTS REQUIRED



▼ 1 Install the switch into the precut hole in the servo tray, in the fuselage, from the bottom. Use the two screws provided with the switch to secure it in place. Drill two 3/32" holes through the tray for the screws to pass through.

▼ 2 Using a 3/32" drill bit, drill a hole through the side of the fuselage, opposite the muffler, even with the switch.

▼ 3 Make a push-pull lever out of scrap wire. Attach the wire to the switch lever and route the wire out the side of the fuselage, through the hole you drilled.

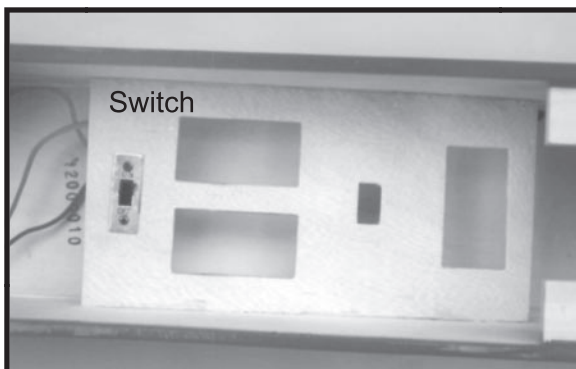

⚠ Some switches come with a hole drilled through the switch tab for this very purpose. If your switch does not, remove the switch and drill a 3/32" hole through the middle of the switch tab.

⚠ 4. Install the rubber grommets and brass collets onto the elevator, rudder and throttle servos. Test fit the servos into the preinstalled servo tray. Because the size of servos differ, you may need to adjust the size of the precut openings in the tray.

▼ 5. Position the servos into the servo tray with the output shafts orientated as shown below. Drill 1/16" pilot holes through the tray for each of the mounting screws.

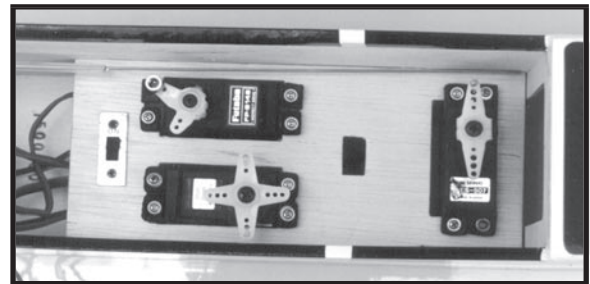

## PARTS REQUIRED

- ▼ {1} Horizontal Stabilizer with Elevator Halves

## ALIGNING THE HORIZONTAL STABILIZER

- ▼ 1) Using a ruler and a pen, locate the centerline of the horizontal stabilizer, at the trailing edge, and place a mark. Use a triangle and extend this mark, from back to front, across the top of the stabilizer. Also extend this mark down the back of the trailing edge of the stabilizer.

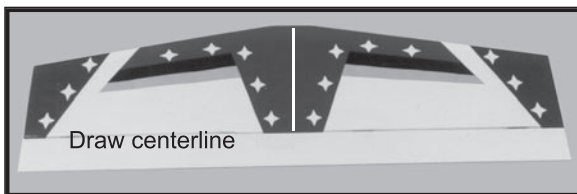

- ⚠ The top of the stabilizer does **not** have the hinge pins exposed.

- ▼ 2) Using a modeling knife, carefully remove the covering from over the vertical stabilizer mounting slot in the top of the fuselage.

- ▼ 3) Slide the stabilizer into place in the precut slot in the rear of the fuselage. The stabilizer should be pushed firmly against the front of the slot.

- ▼ 4) Install the wing onto the fuselage. Align the centerline drawn on the top and the rear of the stabilizer with the center of the fuselage. When that is aligned, hold the stabilizer in that position using T-pins or masking tape. Align the horizontal stabilizer with the wing. When viewed from the rear, the horizontal stabilizer should be level with the wing. If it is not level, use sandpaper and sand down the high side of the stabilizer mounting platform until the proper alignment is achieved. The tips of the stabilizer should also be equal distance from the tips of the wing.

- ▼ 5) When you are satisfied with the alignment, hold the stabilizer in place with T-pins or masking tape, but do not glue at this time.

## MOUNTING THE HORIZONTAL STABILIZER

- ▼ 6) With the stabilizer held firmly in place, use a pen and draw lines onto the stabilizer where it and the fuselage sides meet. Do this on both the right and left sides and top and bottom of the stabilizer.

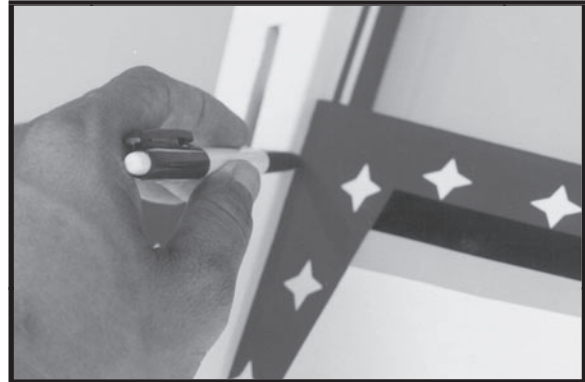

- ▼ 7) Remove the stabilizer. Using the lines you just drew as a guide, carefully remove the covering from between them using a modeling knife.

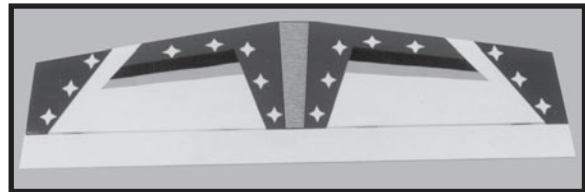

- ⚠ When cutting through the covering to remove it, cut with only enough pressure to only cut through the covering itself. Cutting into the balsa structure may weaken it.

- ▼ 8) Using a modeling knife, carefully remove the covering that overlaps the stabilizer mounting platform sides in the fuselage. Remove the covering from both the top and the bottom of the platform sides.

- ▼ 9) When you are sure that everything is aligned correctly, mix up a generous amount of Flash 30 Minute Epoxy. Apply a thin layer to the top and bottom of the stabilizer mounting area and to the stabilizer mounting platform sides in the fuselage. Slide the stabilizer in place and realign. Double check all of your measurements once more before the epoxy cures. Hold the stabilizer in place with T-pins or masking tape and remove any excess epoxy using a paper towel and rubbing alcohol.

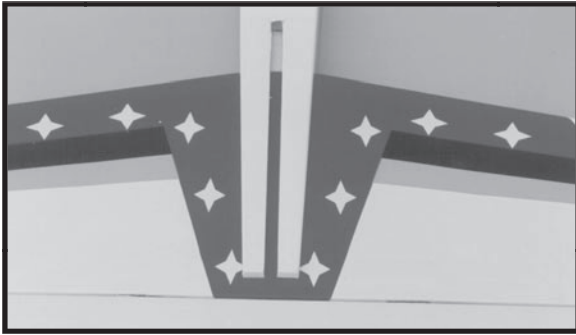

▼ 10) After the epoxy has fully cured, remove the masking tape or T-pins used to hold the stabilizer in place. Carefully inspect the glue joints. Use more epoxy to fill in any gaps that may exist that were not filled previously and clean up the excess using a paper towel and rubbing alcohol.

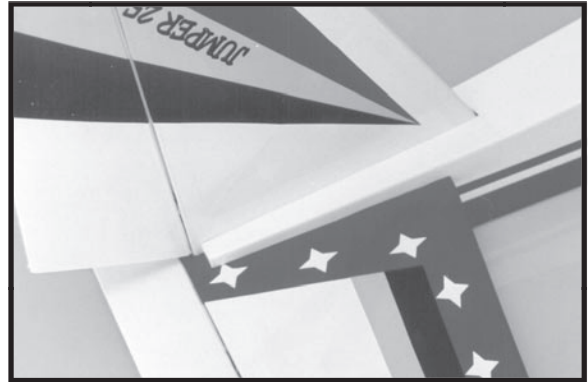

▼ 3) While holding the vertical stabilizer firmly in place, use a pen and draw a line on each side of the vertical stabilizer where it meets the top of the fuselage.

## VERTICAL STABILIZER INSTALLATION

### PARTS REQUIRED

▼ {1} Vertical Stabilizer with Rudder

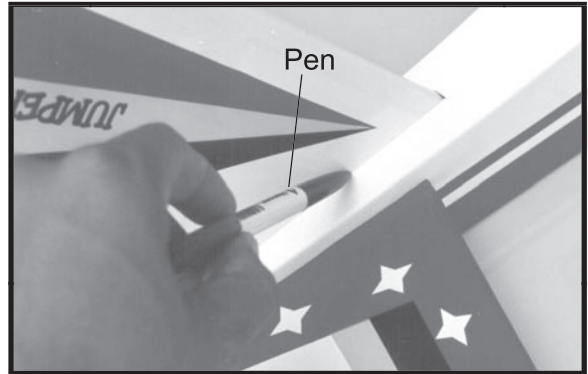
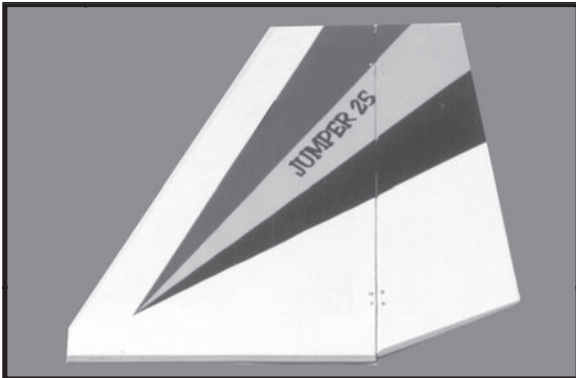

▼ 4) Remove the stabilizer. Using a modeling knife, remove the covering from below the lines you drew. Also remove the covering from the bottom edge of the stabilizer and the bottom and top edges of the filler block. Leave the covering in place on the sides of the filler block.

## ALIGNING THE VERTICAL STABILIZER

▼ 1) Using a modeling knife, remove the covering from over the precut hinge slot cut into the lower rear portion of the fuselage. This slot accepts the lower rudder hinge.

▼ 2) Slide the vertical stabilizer into the slot in the top of the fuselage. The rear edge of the stabilizer should be flush with the rear edge of the fuselage and the lower rudder hinge should engage the precut hinge slot in the lower fuselage. The bottom edge of the stabilizer should also be firmly pushed against the top of the horizontal stabilizer.

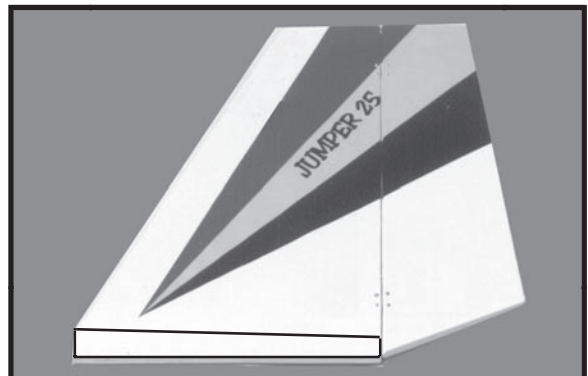

⚠ When cutting through the covering to remove it, cut with only enough pressure to only cut through the covering itself. Cutting into the balsa structure may weaken it.



▼ 5) Slide the vertical stabilizer back in place. Using a triangle, check to ensure that the vertical stabilizer is aligned 90° to the horizontal stabilizer.

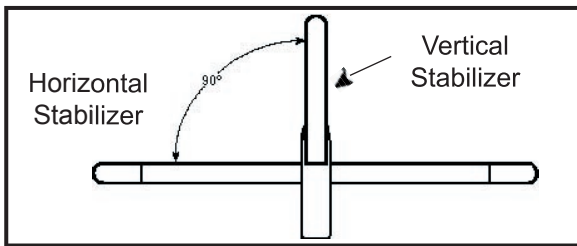

▼ 6) When you are sure that everything is aligned correctly, mix up a generous amount of Flash 30 Minute Epoxy. Apply a thin layer to the mounting slot in the top of the fuselage and to the sides and bottom of the vertical stabilizer mounting area. Apply epoxy to the bottom and top edges of the filler block and to the lower hinge also. Set the stabilizer in place and realign. Double check all of your measurements once more before the epoxy cures. Hold the stabilizer in place with T-pins or masking tape and remove any excess epoxy using a paper towel and rubbing alcohol. Allow the epoxy to fully cure before proceeding.

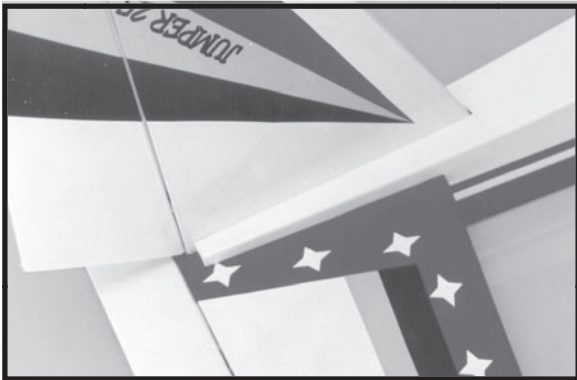

## CONTROL HORN INSTALLTION

▼ 1) Locate the two nylon control horns, three nylon control horn backplates and six 2 x 15mm machine screws.

▼ 2) Position the two elevator horns on the bottom side of each elevator, 1 - 1/8" out from the sides of the fuselage. The clevis attachment holes should be positioned over the hinge line.

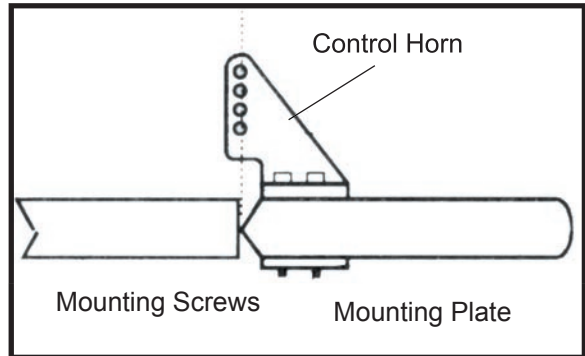

▼ 3) Using a modeling knife, remove the covering from over the two precut pushrod slots, one on left side of the fuselage and one on the right side of the fuselage, under the forward half of the horizontal stabilizer.

▼ 4) Using a 5/64" drill bit and the control horns as a guide, drill the mounting holes through the elevator halves.

▼ 5) Mount the control horns by inserting the screws through the control horn bases and elevator halves, then into the mounting backplates. Do Not overtighten the screws or the backplates may crush the wood.

▼ 6) Position the rudder control horn on the left side of the airplane 3/4" up from the bottom of the rudder. Mount the control horn parallel with the horizontal stabilizer, not in-line with the rudder hinge line.

▼ 7) Install the rudder control horn using the same method as with the elevator control horns.

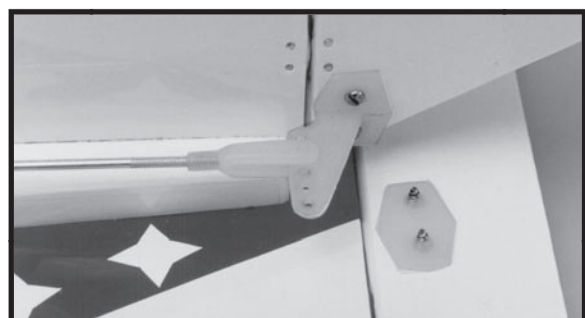

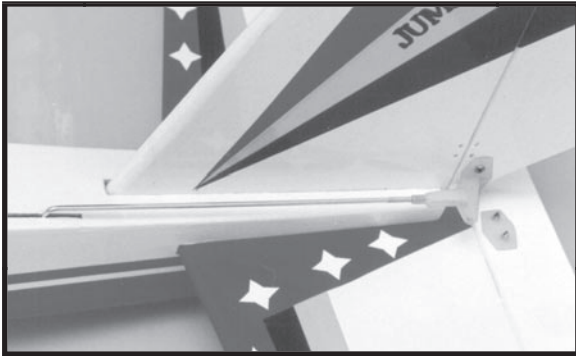

## PUSHROD INSTALLATION

- ▼ 1) Locate two nylon clevises and two nylon keepers from the nylon parts tree.
- ▼ 2) Install the elevator pushrod into the fuselage. To help make installation easier, thread string down through the elevator pushrod exits and into the servo compartment in the fuselage. Tie the thread to the threaded pushrod wires of the elevator pushrod. Pull the pushrod through the exit slots.
- ▼ 3) Thread the two nylon clevises onto the threaded wires. Attach the clevises to the elevator control horns. You may find it necessary to make slight bends in the wires so they will align with the control horns without binding.

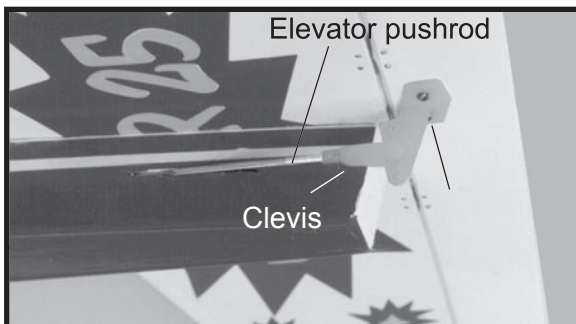

- ▼ 4) Repeat the steps above for installing the rudder pushrod. See fig. 19 below.

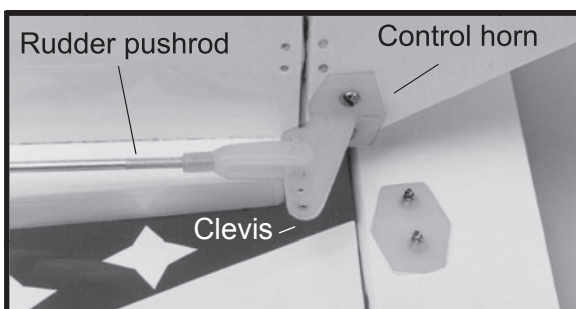

- ▼ 5) Install an adjustable servo connector in the hole closest to the center of the rudder servo arm. You need to use a "dual type" servo arm. Install the connector using the same technique as with the throttle.

- ▼ 6) Connect the elevator and rudder servos to your radio's receiver and turn on the system. Set the trim tabs on the transmitter to neutral and center the servo arms. The elevator and rudder servo arms should be perpendicular to the servos.

- ▼ 7) One at a time, hold the pushrods in position over the respective servos to check for proper servo direction. If any servo turns in the wrong direction, switch your radio's reversing switches as necessary to achieve the correct direction.

- ▼ 8) Insert the nose gear pushrod wire through the adjustable servo connector on the rudder servo arm. Hold the nose gear assembly in the neutral position and tighten the set screw in the servo connector. When satisfied, cut off the excess wire.

- ▼ 9) With the elevator in neutral, mark where the pushrod wire crosses the servo arm. At the mark you just made, use a pair of pliers and bend the wire up 90 degree, making an "L" shape.

- ▼ 10) Remove the servo arm from the servo and insert the wire through the outer most hole. You may need to enlarge the hole so the wire will fit through. Install one nylon keeper on the wire and cut off the excess using wire cutters.

- ▼ 11) Repeat steps #9 - #10 for the rudder pushrod. Notice the position of the servo arms on the servos. See picture as follow.

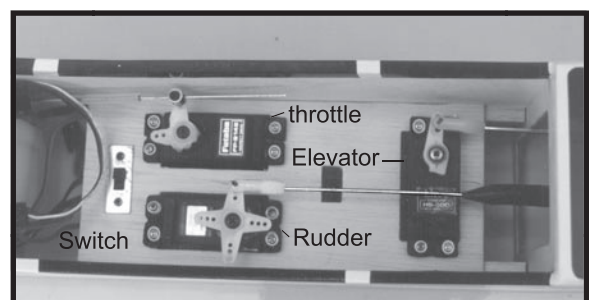

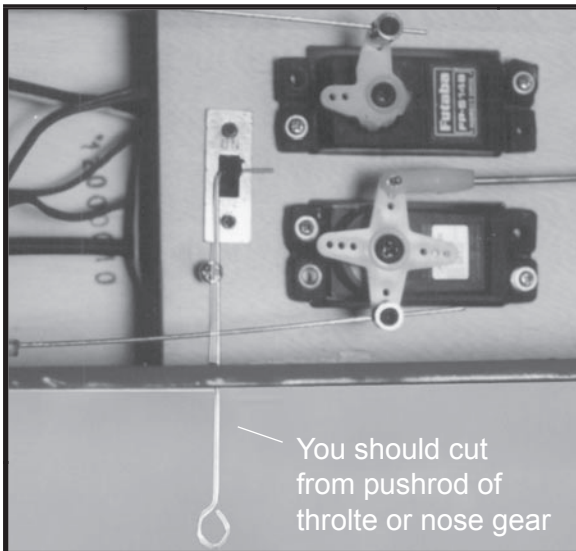

### INSTALLING THE SPINNER

- ▼ 1) Install the spinner backplate, propeller and spinner cone. The spinner cone is held in place using two 3mm x 12mm wood screws.

The propeller should not touch any part of the spinner cone. If it does, use a sharp modeling knife and carefully trim away the spinner cone where the propeller comes in contact with it.



### INSTALLING THE RECEIVER AND BATTERY

- ▼ 2) Plug the four servo leads and the switch lead into the receiver. Plug the battery pack lead into the switch also.
- ▼ 3) Wrap the receiver and battery pack in the protective foam rubber to protect them from vibration
- ▼ 4) Position the battery pack in the fuel tank compartment and the receiver just behind the fuel tank . Use extra foam pieces to hold them in position.



When balancing the airplane you may need to move the battery or receiver forward or aft to achieve proper balance. In our test airplane, using a num .25-.32 two stroke engine, the battery and receiver were mounted as per step # 4.

- ▼ 5) Using a 1/16" drill bit, drill a hole through the side of the fuselage, near the receiver, for the antenna to exit. Route the antenna out of the fuselage and secure it to the vertical stabilizer using a rubber band and a modified servo arm. See picture as follow.

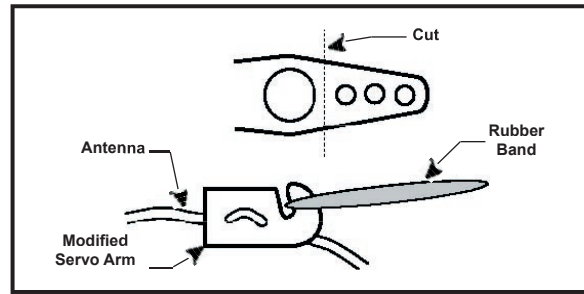

### BALANCING

- ▼ 1) It is critical that your airplane be balanced correctly. Improper balance will cause your plane to lose control and crash. The center of gravity is located 7cm back from the leading edge of the wing, at the fuselage sides. Balance the **Jumper 25** with the fuel tank empty.
- ▼ 2) Mount the wing to the fuselage. Using a couple of pieces of masking tape, place them on the top side of the wing 7cm back from the leading edge, at the fuselage sides.
- ▼ 3) Turn the airplane , place your fingers on the masking tape and carefully lift the plane.
- ▼ 4) If the nose of the plane falls, the plane is nose heavy. To correct this first move the battery pack further back in the fuselage. If this is not possible or does not correct it, stick small amounts of lead weight on the fuselage sides under the horizontal stabilizer. If the tail of the plane falls, the plane is tail heavy. To correct this, move the battery and receiver forward or if this is not possible, stick weight onto the firewall or use a brass heavy hub spinner hub, similar to those offered by Harry Higley. When balanced correctly, the airplane should sit level or slightly nose down when you lift it up with your fingers.



## CONTROL THROWS

- ▼ 1) We highly recommend setting up the **Jumper 25** using the control throws listed at right. We have listed control throws for both initial test flying/sport flying and aerobatic flying.
- ▼ 2) Turn on the radio system, and with the trim tabs on the transmitter in neutral, center the control surfaces by making adjustments to the clevises or adjustable servo connectors. The servo arms should be centered also.
- ▼ 3) When the elevator, rudder and aileron control surfaces are centered, use a ruler and check the amount of the control throw in each surface. **The control throws should be measured at the widest point of each surface!**

<u>INITIAL FLYING/SPORT FLYING</u>		
Ailerons:	3/16" up	3/16" down
Elevator:	5/16" up	5/16" down
Rudder:	3/4" right	3/4" left
<u>AEROBATIC FLYING</u>		
Ailerons:	3/8" up	3/8" down
Elevator:	5/8" up	5/8" down
Rudder:	1-1/4" right	1-1/4" left

Do not use the aerobatic settings for initial test flying or sport flying.

- ▼ 4) By moving the position of the adjustable control horn out from the control surface, you will decrease the amount of throw of that control surface. Moving the adjustable control horn toward the control surface will increase the amount of throw.

## FLIGHT PREPARATION

- ▼ 1) Check the operation and direction of the elevator, rudder, ailerons and throttle.
  - ▼ A) Plug in your radio system per the manufacturer's instructions and turn everything on.
  - ▼ B) Check the elevator first. Pull back on the elevator stick. The elevator halves should move up. If it they do not, flip the servo reversing switch on your transmitter to change the direction.
  - ▼ C) Check the rudder. Looking from behind the airplane, move the rudder stick to the right. The rudder should move to the right. If it does not, flip the servo reversing switch on your transmitter to change the direction.
  - ▼ D) Check the throttle. Moving the throttle stick forward should open the carburetor barrel. If it does not, flip the servo reversing switch on your transmitter to change the direction.
  - ▼ E) From behind the airplane, look at the aileron on the right wing half. Move the aileron stick to the right. The right aileron should move up and the other aileron should move down. If it does not, flip the servo reversing switch on your transmitter to change the direction.
- ▼ 2) Check Control Surface Throw.
  - ▼ A) The Rudder should move 3/4" left and 3/4" right from center. If it moves too far, turn the adjustable control horn out away from the rudder. Do the opposite if there is not enough throw.
  - ▼ B) Both elevator halves should move 5/16" up and 5/16" down from center. If they move too far, turn the adjustable control horns out away from the elevator halves. Do the opposite if there is not enough throw. Both elevator halves should also travel the same amount throughout their total movement.
  - ▼ C) The ailerons should move 3/16" up and 3/16" down from center. If the ailerons



move too much, turn the adjustable control horns out away from the wing. Do the opposite if there is not enough throw. It is important that both ailerons move the same amount, both up and down.

▼ D) Once the control throws and movements are set, tubing must be added to the clevises to ensure they do not release in the air. Cut a piece of fuel line into five 1/4" long pieces. Unsnap the clevises and slip one piece over each clevis. Snap the clevises back in place and slide the tubing up over them.

### **PREFLIGHT CHECK**

- ▼ 1) Completely charge your transmitter and receiver batteries before your first day of flying.
- ▼ 2) Check every bolt and every glue joint in the PC-9 to ensure that everything is tight and well bonded.

▼ 3) Double check the balance of the airplane. Do this with the fuel tank empty.

▼ 4) Check the control surfaces. All should move in the correct direction and not bind in any way.

▼ 5) If your radio transmitter is equipped with dual rate switches double check that they are on the low rate setting for your first few flights.

▼ 6) Check to ensure the control surfaces are moving the proper amount for both low and high rate settings.

▼ 7) Check the receiver antenna. It should be fully extended and not coiled up inside the fuselage.

▼ 8) Properly balance the propeller. An out of balance propeller will cause excessive vibration which could lead to engine and/or airframe failure.

***We wish you many safe and enjoyable flights with your Jumper 25.***



# SEAGULL 40

## LOW WING TRAINER

Hand-made Almost Ready to Fly R/C Model Aircraft

### ASSEMBLY MANUAL

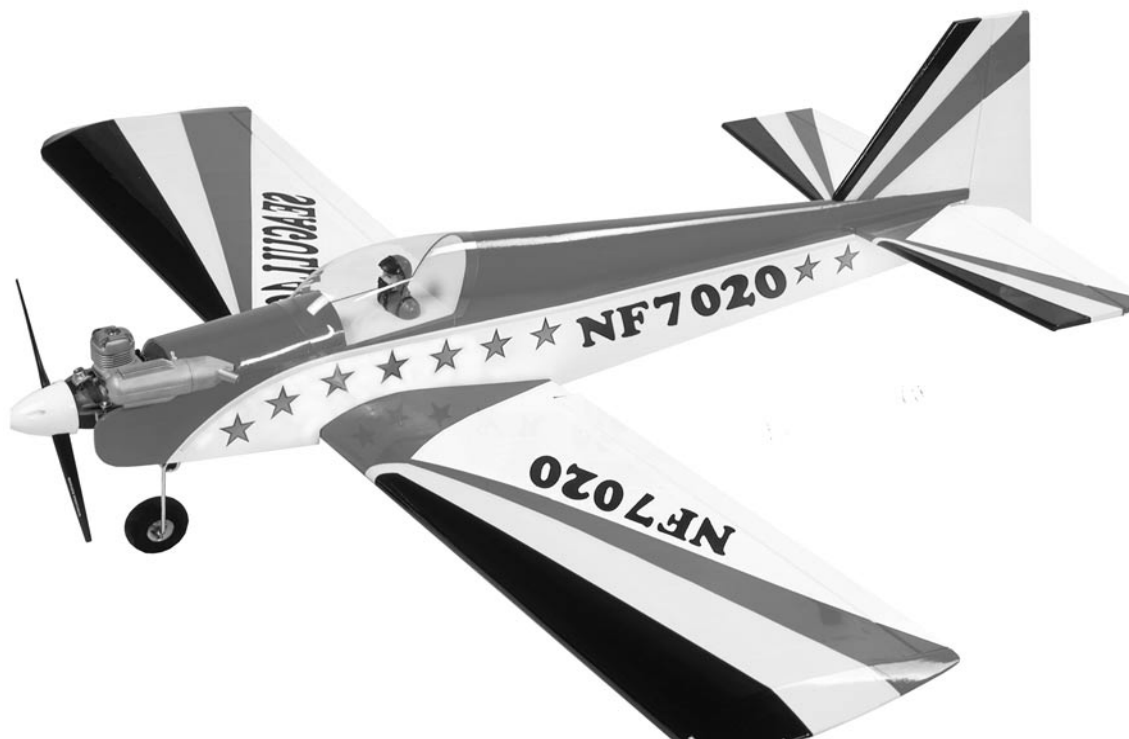

## FACTORY BUILT MODEL

### Specifications

Wingspan \_\_\_\_\_ , 145cm  
Wing area \_\_\_\_\_ 4100Cm<sup>2</sup>  
Approximate flying weight \_\_\_\_\_ , 2.5kg  
Recommended engine size \_\_\_ 0.32-0.46 cu. ins 2-stroke  
\_\_\_\_\_ 0.52 cu. ins 4-stroke  
Recommended R/C \_\_\_\_\_ 4 channel minimum  
Flying skill level \_\_\_\_\_ Low wing Trainer

### Additional items required

Engine  
4 Channel or greater Radio Control system  
Glues  
Tools  
Starting Equipment

### Kit features

- Ready-made—minimal assembly & finishing required
- Ready-covered—including decals, trim & covering
- Factory-installed pushrod
- Factory-installed metal engine mount
- Factory-pinned & glued control surface hinges for ultimate safety
- Comprehensive hardware pack including wheels, tank, spats, undercarriage & spinner
- Photo-illustrated step-by-step Assembly Manual



**FACTORY BUILT MODEL**

Made in Vietnam



# PC-9 semi Scale ARF Model

Engine size .40-.46 Cu. Ins 2- stroke

*Hand-made Almost Ready to Fly R/C Model Aircraft*

## ASSEMBLY MANUAL



### FACTORY BUILT MODEL

#### Specifications

Wingspan \_\_\_\_\_ 161cm  
Wing area \_\_\_\_\_ 4025 sq. cm.  
Approximate flying weight \_\_\_\_\_ 2.6-2.9kg  
Recommended engine size \_\_\_\_ 0.40-0.46 cu. ins 2-stroke  
Recommended R/C \_\_\_\_\_ 4 channel minimum  
Flying skill level \_\_\_\_\_ Intermediate/advanced

#### Additional items required

Engine  
4 Channel or greater Radio Control system  
Glues  
Tools  
Starting Equipment

### Kit features

- Ready-made—minimal assembly & finishing required
- Ready-covered—including decals, trim & covering
- Factory-installed pushrods
- Factory-installed metal engine mount
- Factory-pinned & glued control surface hinges for ultimate safety
- Comprehensive hardware pack including wheels, tank, spats, undercarriage & spinner
- Photo-illustrated step-by-step Assembly Manual



**FACTORY BUILT MODEL**

Made in Vietnam



# SPACE WALK

*Hand-made Almost Ready to Fly R/C Model Aircraft*

## ASSEMBLY MANUAL

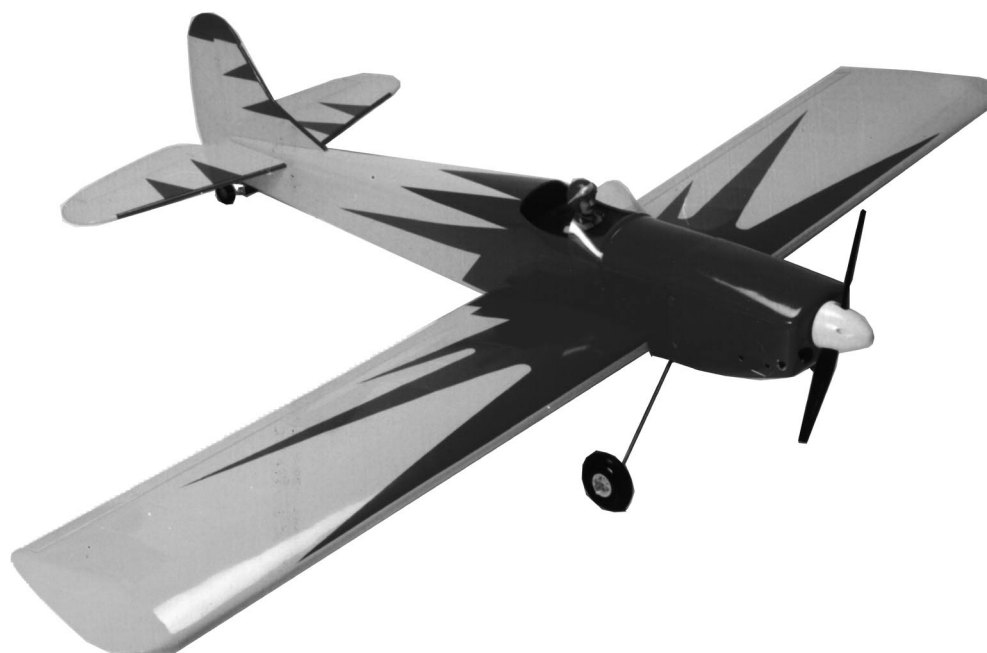

### **FACTORY BUILT MODEL**

#### **Specifications**

Wingspan \_\_\_\_\_ 160cm  
Length \_\_\_\_\_ 103 cm  
Wing area \_\_\_\_\_ 4240cm<sup>2</sup>  
Recommended engine size \_\_\_\_\_ 0.46-0.61 cu. ins 2-stroke  
Recommended R/C \_\_\_\_\_ 4 channel minimum  
Flying skill level \_\_\_\_\_ Intermediate/advanced

#### **Additional items required**

Engine  
4 Channel or greater Radio Control system  
Glues  
Tools  
Starting Equipment

#### **Kit features**

- **Ready-made—minimal assembly & finishing required**
- **Ready-covered—including decals, trim & covering**
- **Factory-installed pushrods**
- **Factory-installed metal engine mount**
- **Factory-pinned & glued control surface hinges for ultimate safety**
- **Comprehensive hardware pack including wheels, tank, spats, undercarriage & spinner**
- **Photo-illustrated step-by-step Assembly Manual**



**FACTORY BUILT MODEL**

Made in Vietnam



# F-4U CORSAIR

Engine size .61-.90 Cu. Ins 2- stroke

*Hand-made Almost Ready to Fly R/C Model Aircraft*

## ASSEMBLY MANUAL



## FACTORY BUILT MODEL

### Specifications

Wingspan \_\_\_\_\_ 62 inches, 157.5cm

Wing area \_\_\_\_\_ 700 sq. in.

Approximate flying weight \_\_\_\_\_ 7-9.5lb, 3.2-4.3kg

Recommended engine size \_\_\_\_ 0.61-0.90 cu. ins 2-stroke

\_\_\_\_\_.91-.120 cu. ins 4-stroke

Recommended R/C \_\_\_\_\_ 4 channel minimum

Flying skill level \_\_\_\_\_ Intermediate/advanced

### Additional items required

Engine

4 Channel or greater Radio Control system

Glues

Tools

Starting Equipment

### Kit features

- Ready-made—minimal assembly & finishing required
- Ready-covered—including decals, trim & covering
- Factory-installed pushrods
- Factory-installed metal engine mount
- Factory-pinned & glued control surface hinges for ultimate safety
- Comprehensive hardware pack including wheels, tank, spats, undercarriage & spinner
- Photo-illustrated step-by-step Assembly Manual



**FACTORY BUILT MODEL**

Made in Vietnam

Telling us what you like and do not like, determines what model kits we make and how we make them. We would therefore appreciate it if you would take a few minutes of your time to answer the following questions about this kit.

- ▼. Kit: **Jumper 25**- ARTF
- ▼. Where did you learn about this kit?
  - Magazine Ads       Friend
  - Model Shop         Other
  - Internet
- ▼. What influenced you the most to buy this kit?
  - Magazine Ads       Price
  - Type of Model      Box art
  - Recommendation    Other
  - Internet
- ▼. Did you have any trouble understanding the written instructions? If yes, please explain.
  - Yes                       No

---

---

---

---

- ▼. Did you have any trouble understanding any of the photographs? If yes, please explain.
  - Yes                       No

---

---

---

---

- ▼. Were any of the kit parts?
  - Damaged               Wrong Size
  - Missing                 Wrong Shape

If you checked any of the boxes above, did you contact our Customer Service Department to resolve the problem?

  - Yes       No

- ▼. Was any of the assembly difficult for you? If yes, please explain.

- ▼. What did you like most about this kit?
  - Assembly Manual     Parts Fit
  - Hardware Supplied  Price
  - Other

---

---

---

- ▼. Are you satisfied with the finished model? If no, please explain.
  - Yes                       No

---

---

---

- ▼. How does this kit compare to similar kits by other manufacturers?
  - Better Than             As good
  - Not as Good

Additional Comments:

Please return this sheet to (Europe):  
J. Perkins Distribution Limited  
90-96 Greenwich High Road, London SE10 8JG,  
England  
Fax: 0044-208-692 2469

Please return this sheet to (Australia):  
Model Engines  
44 Downing Street, Oakleigh, Melbourne 3166,  
Australia  
Fax: 03-9569-0930



Fold along dotted line

Post Office  
will not  
deliver  
without  
proper  
postage

Please return this sheet to (Europe):  
J. Perkins Distribution Limited  
90-96 Greenwich High Road, London SE10 8JG,  
England  
Fax: 0044-208-692 2469

Please return this sheet to (Australia):  
Model Engines  
44 Downing Street, Oakleigh, Melbourne 3166,  
Australia  
Fax: 03-9569-0930

Fold along dotted line